

# Dynamic Field Theory: Selection decisions

Gregor Schöner

[gregor.schoener@ini.rub.de](mailto:gregor.schoener@ini.rub.de)

# Recall from last lecture ...

- **Attractor states in neural dynamic fields and their instabilities**
  - self-stabilized peaks vs. sub-threshold activation patterns
  - detection and reverse detection instability
  - selection
  - working memory
  - boost-driven detection...

# Detection instability

- just responding to input is a “decision” in which the “off” state becomes unstable and the system goes to the alternate “on” state
- that detection decision is self-stabilized... bistable regime..
- critical for the emergence of “events” at discrete times

- evidence for the detection instability from perceptual hysteresis

*H. S. Hock, G. Schöner / Seeing and Perceiving 23 (2010) 173–195*

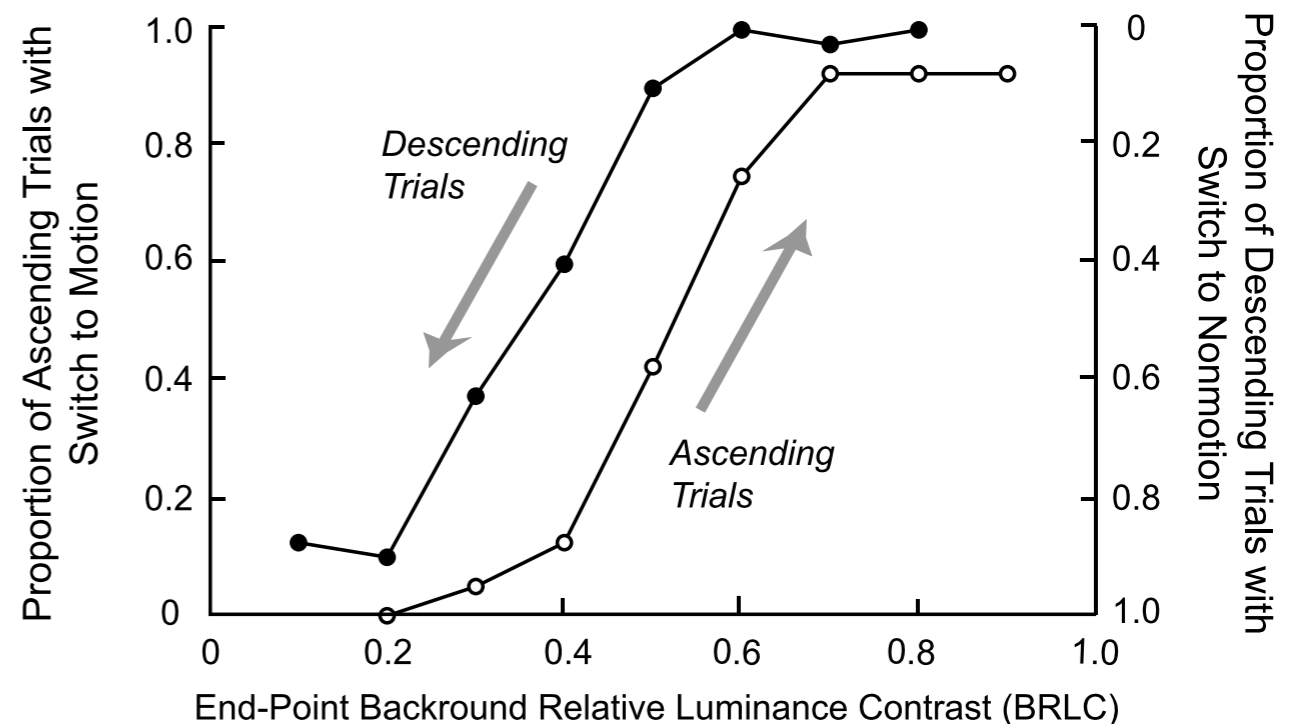

# selection instability

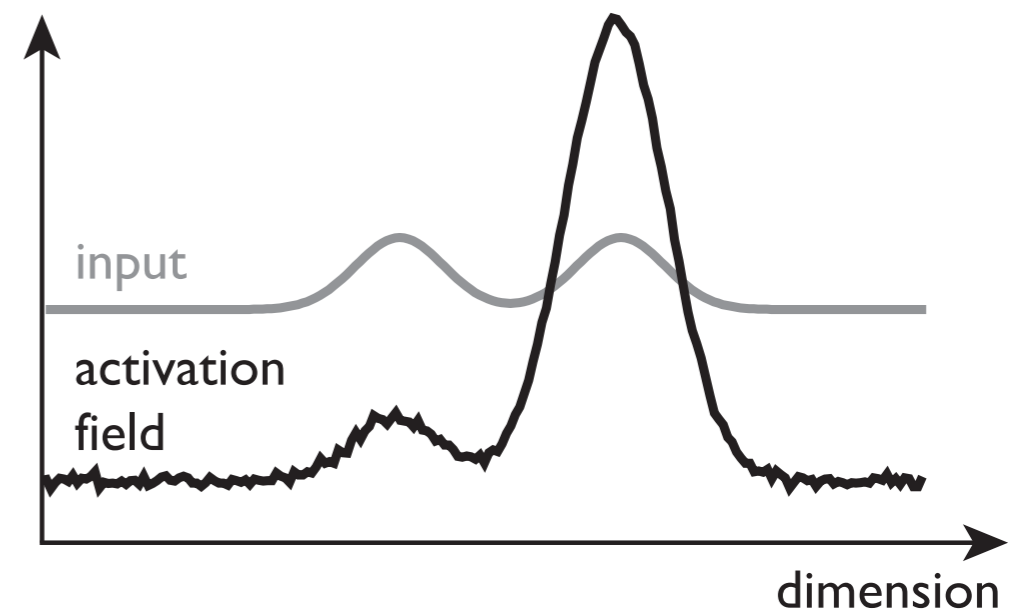
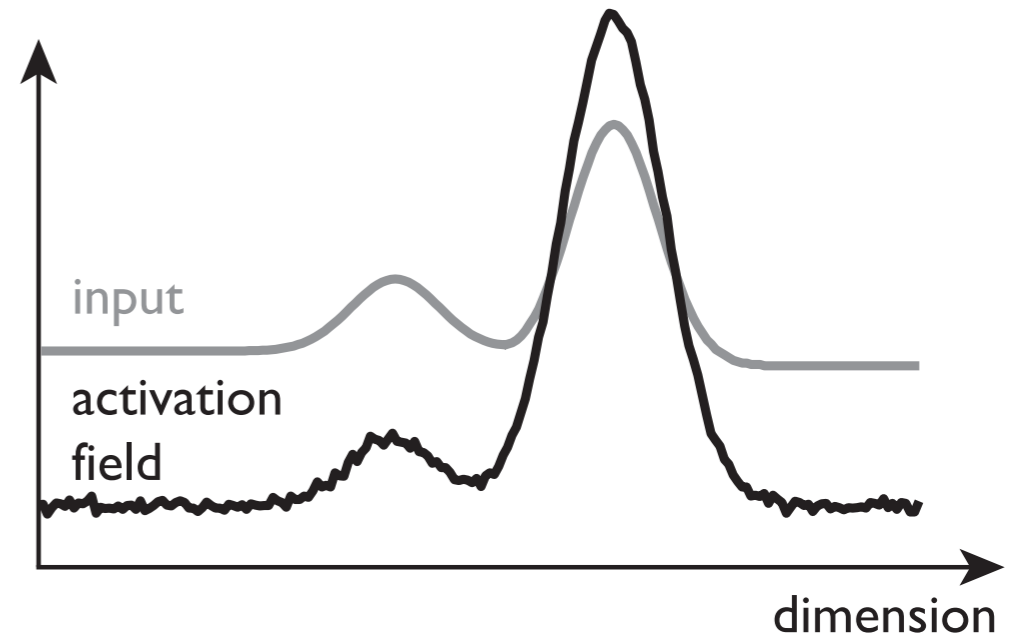
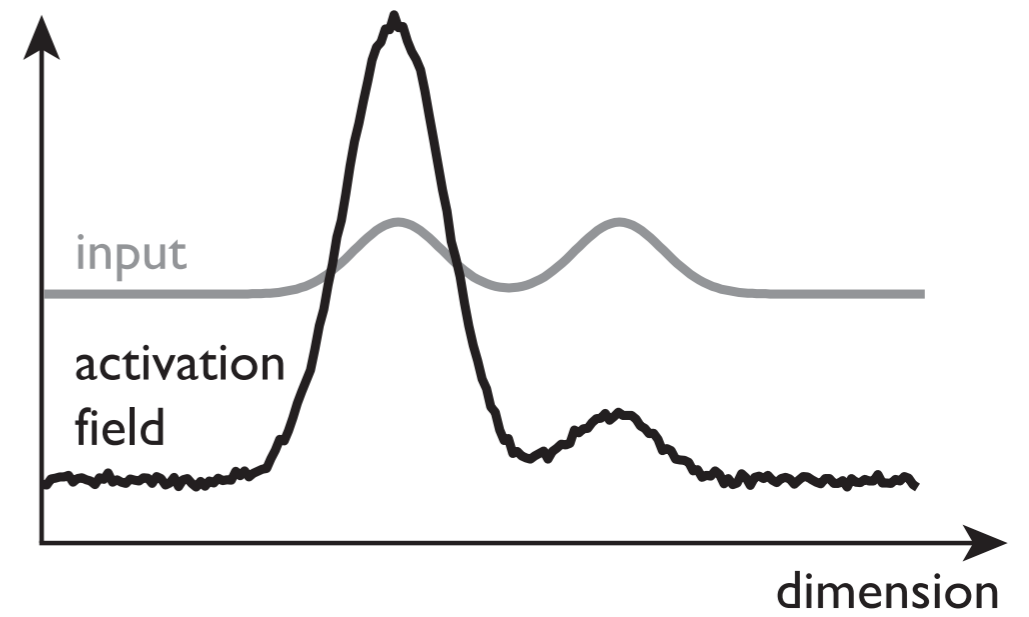

# stabilizing selection decisions

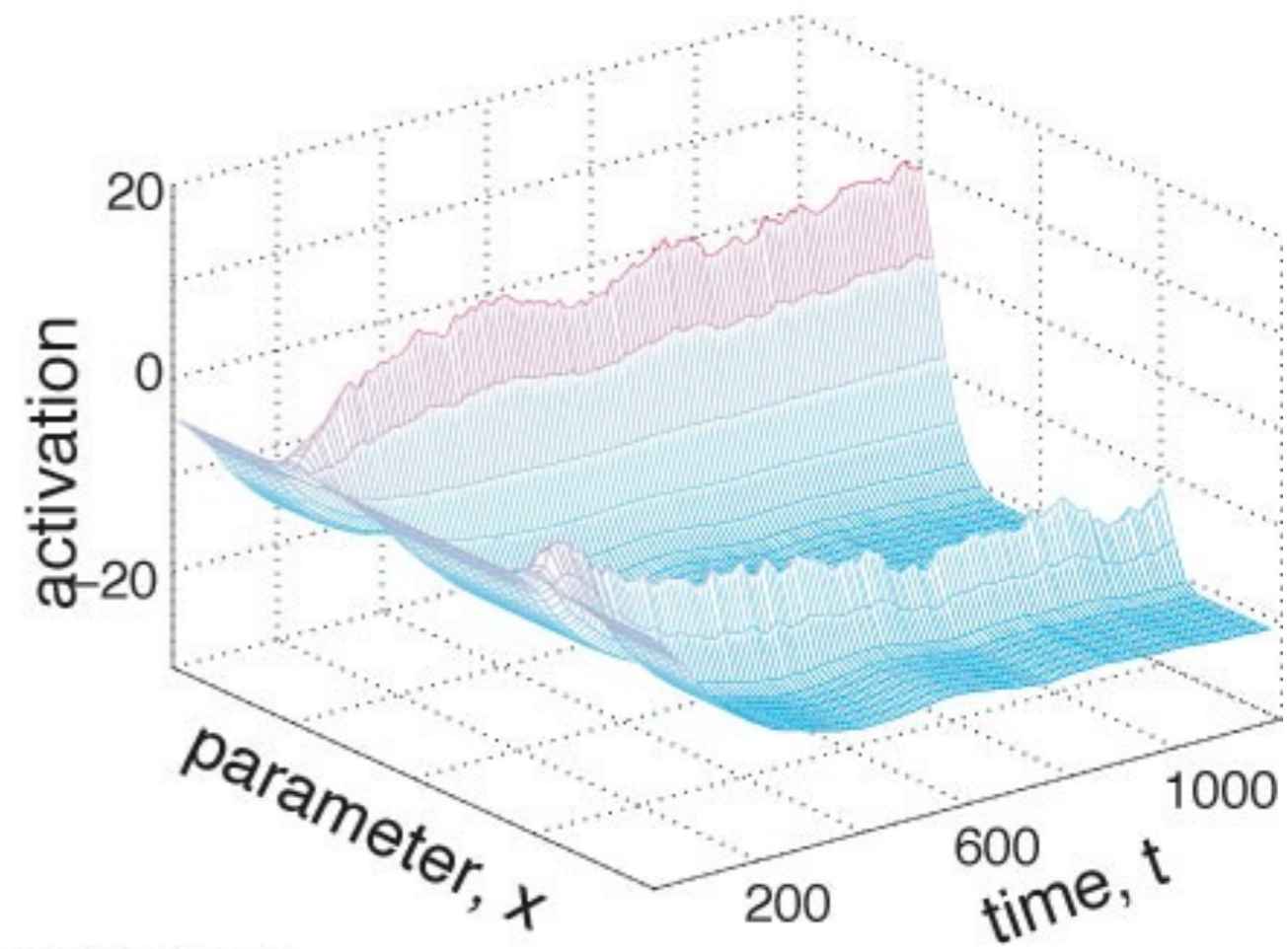
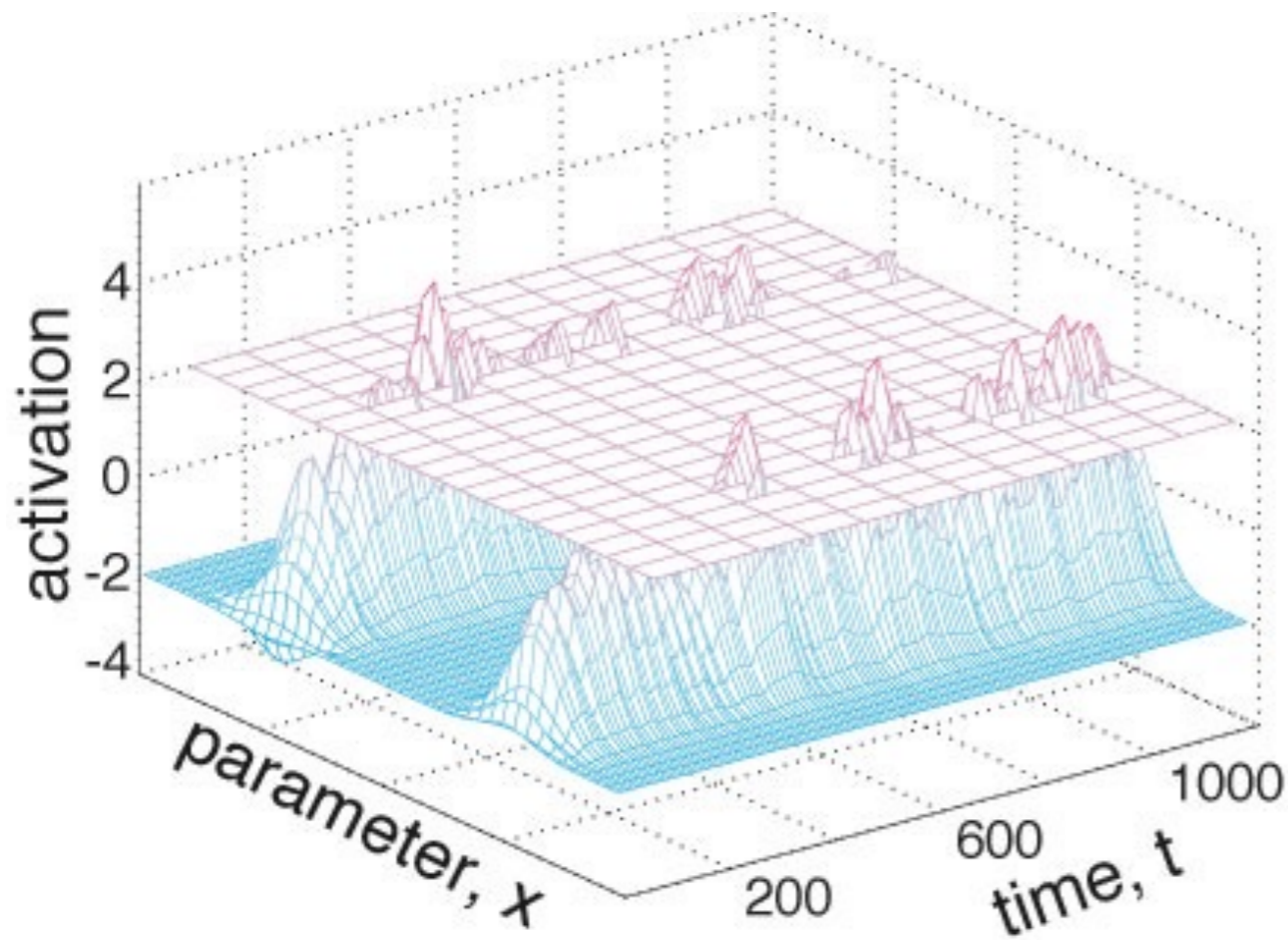

[Wilimzig, Schöner, 2006]

# behavioral signatures of selection decisions

- in most experimental situations, the correct selection decision is cued by an *imperative signal* leaving no actual freedom of choice to the participant (only the freedom of *error*)
- when performance approaches chance level, this approximates *free choice*
- reasons are experimental (uncertainty, strategies... )
- (task set plays a major role ... to be discussed later)

# choice without imperative signal

- selecting a new saccadic location

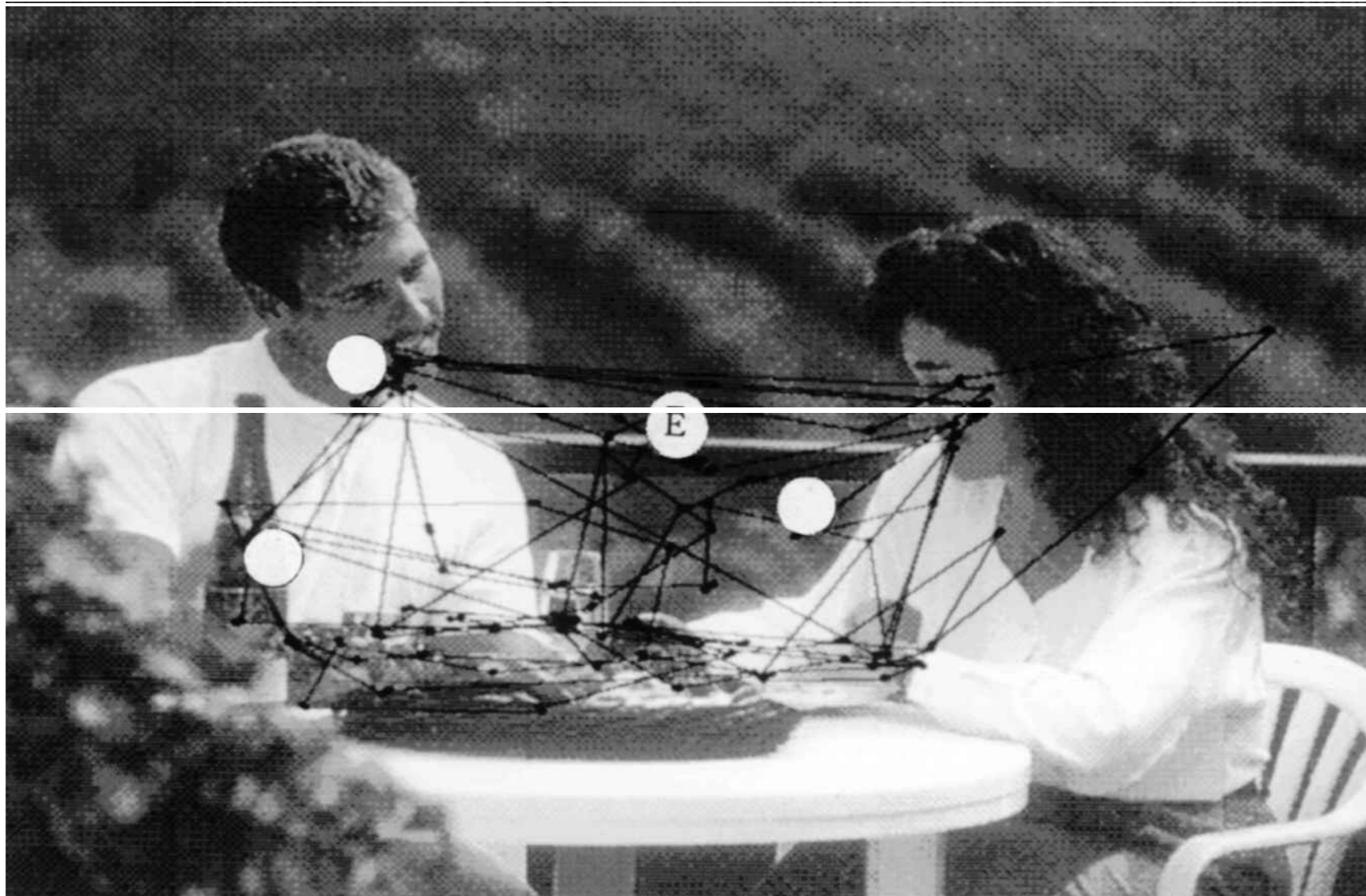

[O'Reagan et al., 2000]

# saccadic selection

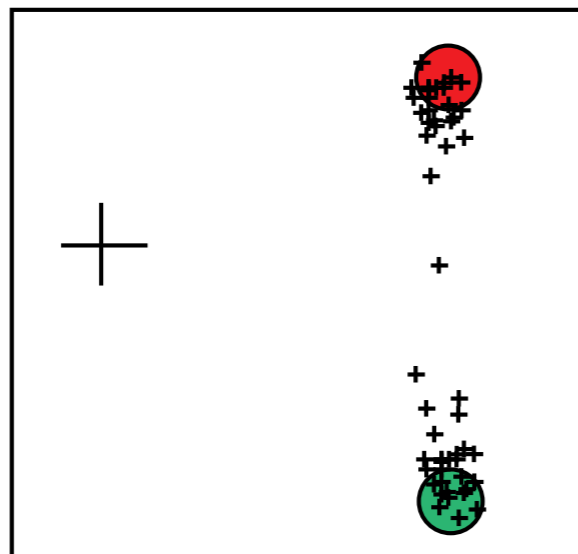
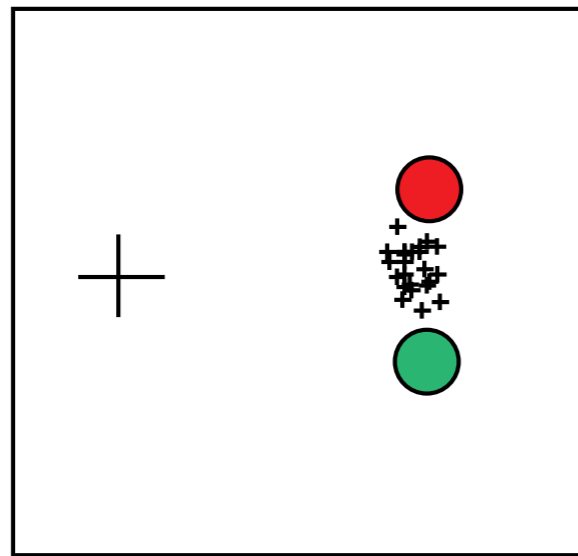

initial  
fixation

visual  
targets

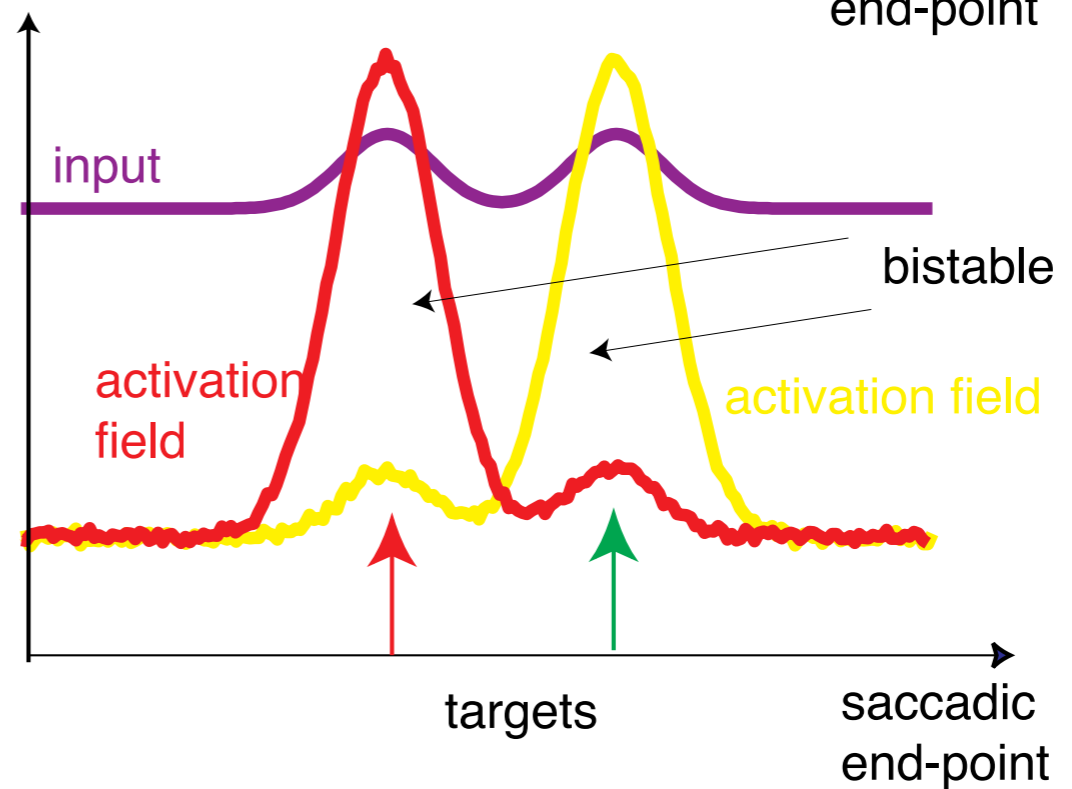
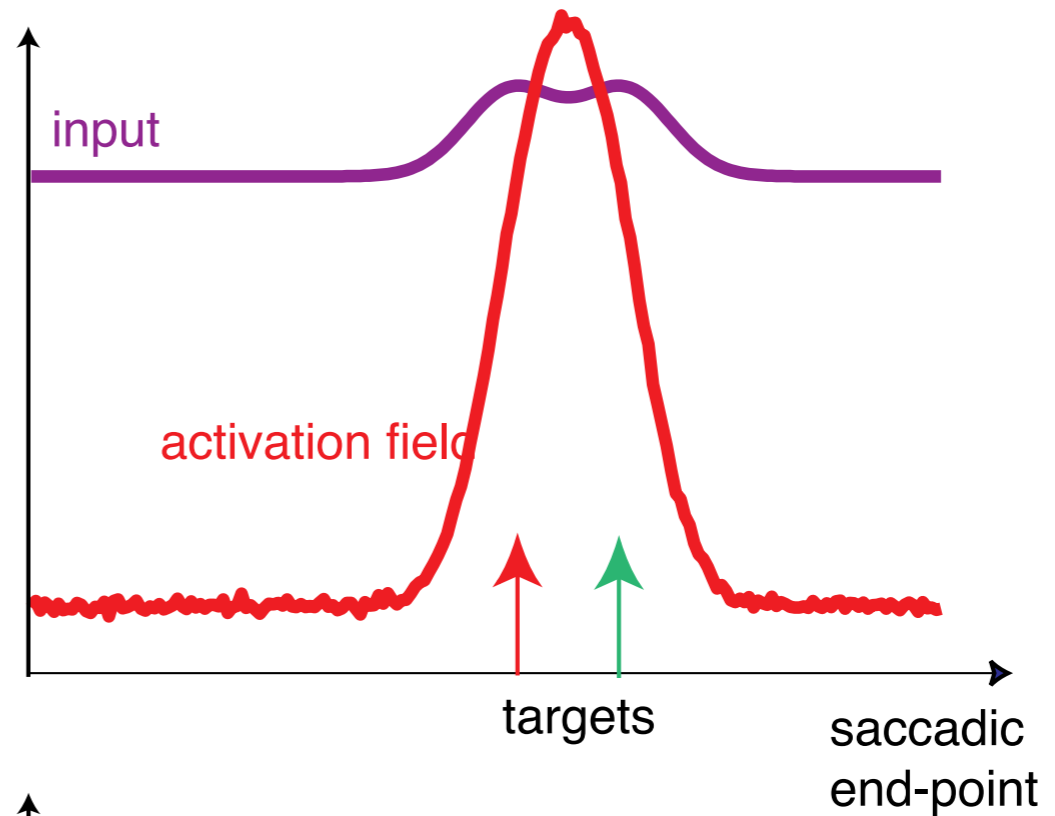

[after: Ottes et al., Vis. Res. 25:825 (85)]

[after Kopecz, Schöner: Biol Cybern 73:49 (95)]



# saccadic selection

- in reduced visual environment, selections become relatively reproducible...
- selection decisions depend on metrics of visual stimuli
  - averaging vs. selection

# saccadic selection

- time course of saccadic selection:
- transition from averaging to selection

single target

target

non-target

averaging fraction

participant 1

participant 2

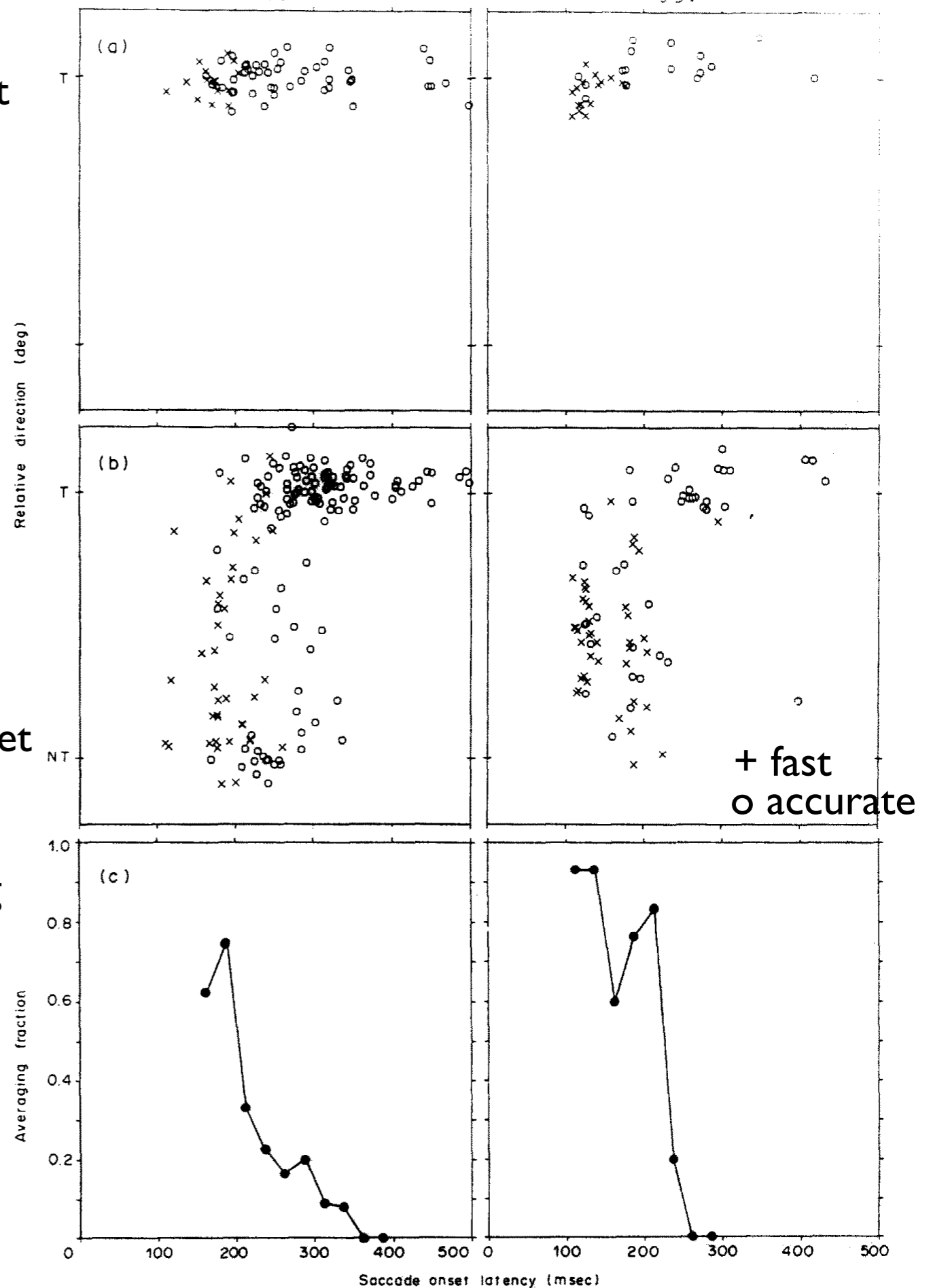

# saccadic selection

- understanding the time course of selection requires a re-examination of the theory

... so far we assumed

- that a single population of activation variable mediates both the excitatory and the inhibitory coupling required to make peaks attractors

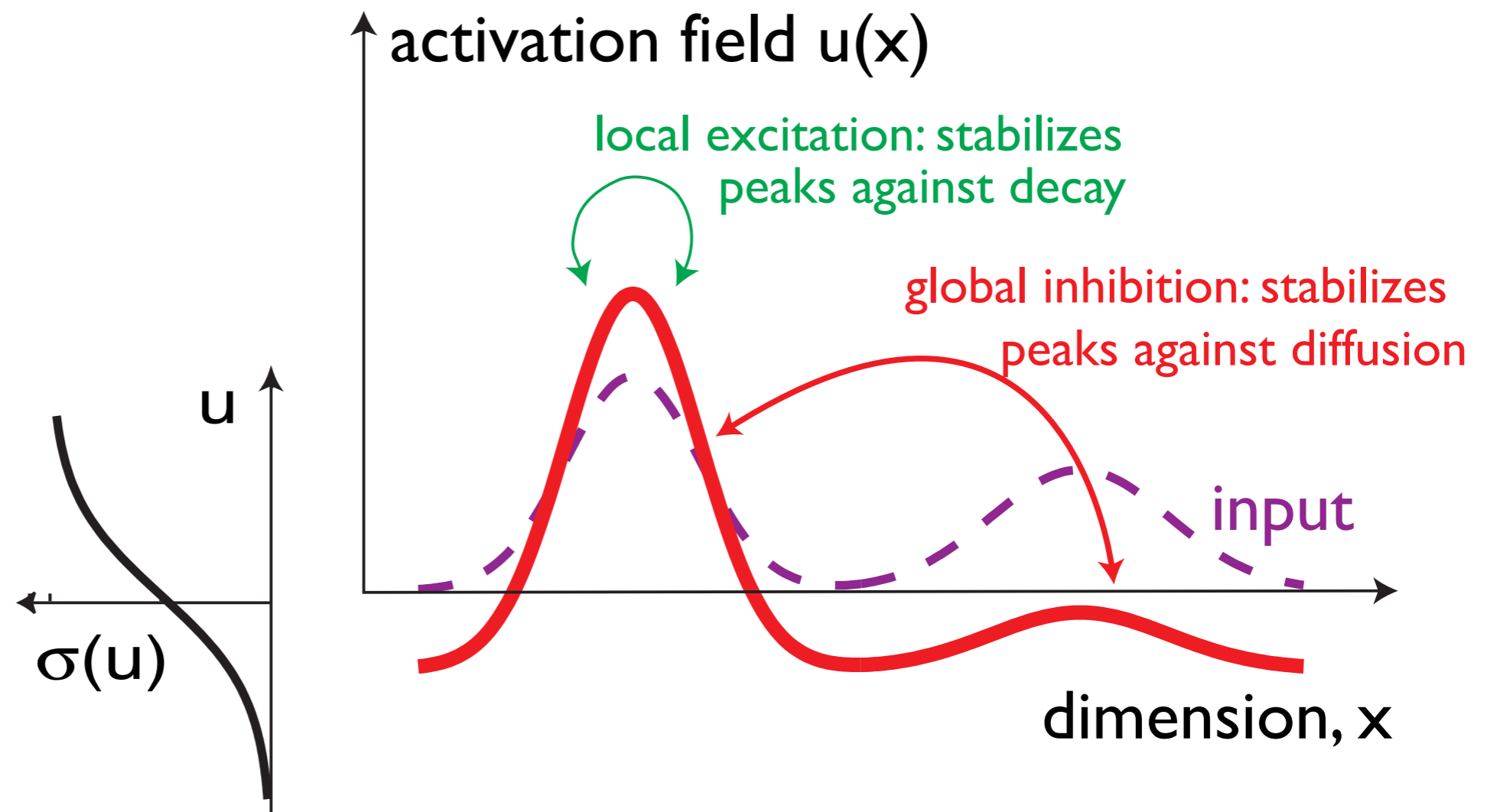

# But: Dale's law

- says: every neuron forms with its axon only one type of synapse on the neurons it projects onto
- and that is either excitatory or inhibitory

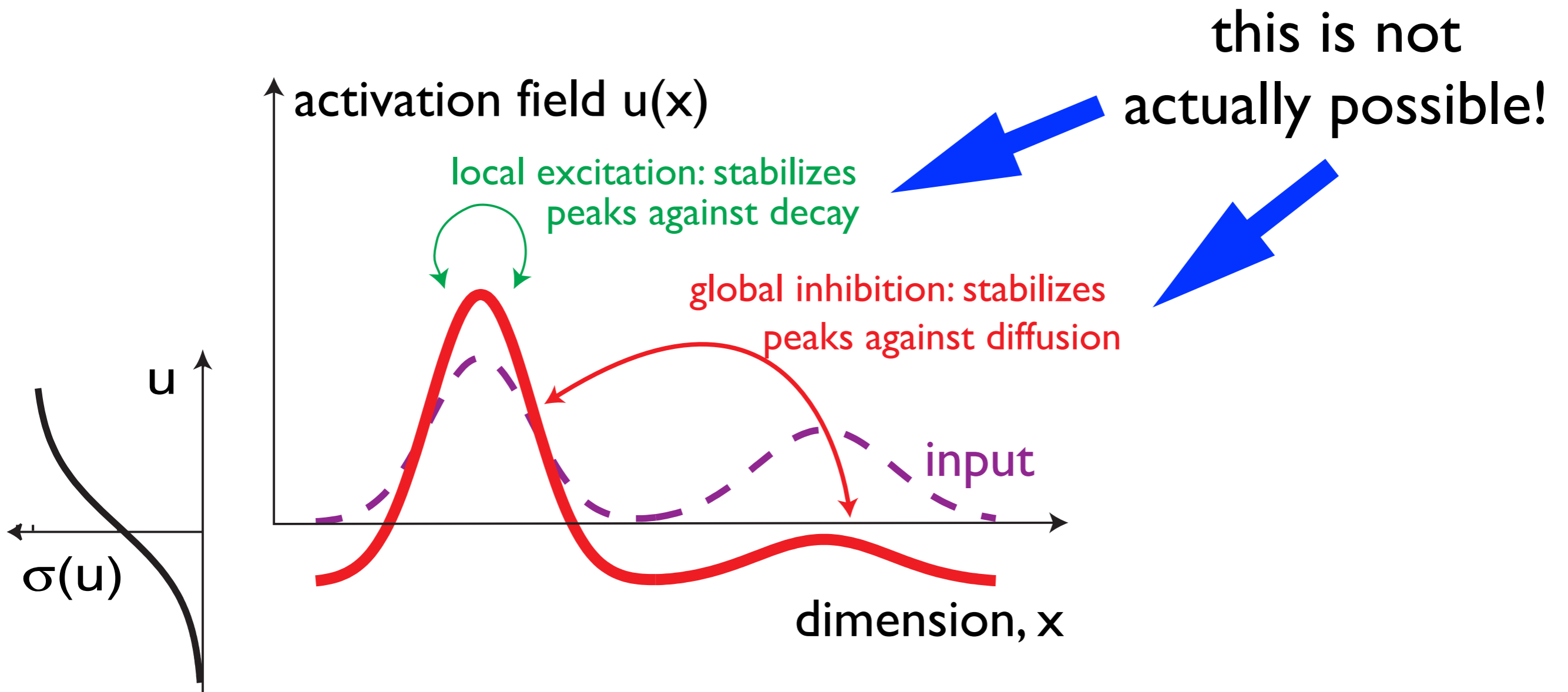

# 2 layer neural fields

- inhibitory coupling is mediated by inhibitory interneurons that
- are excited by the excitatory layer
- and in turn inhibit the inhibitory layer

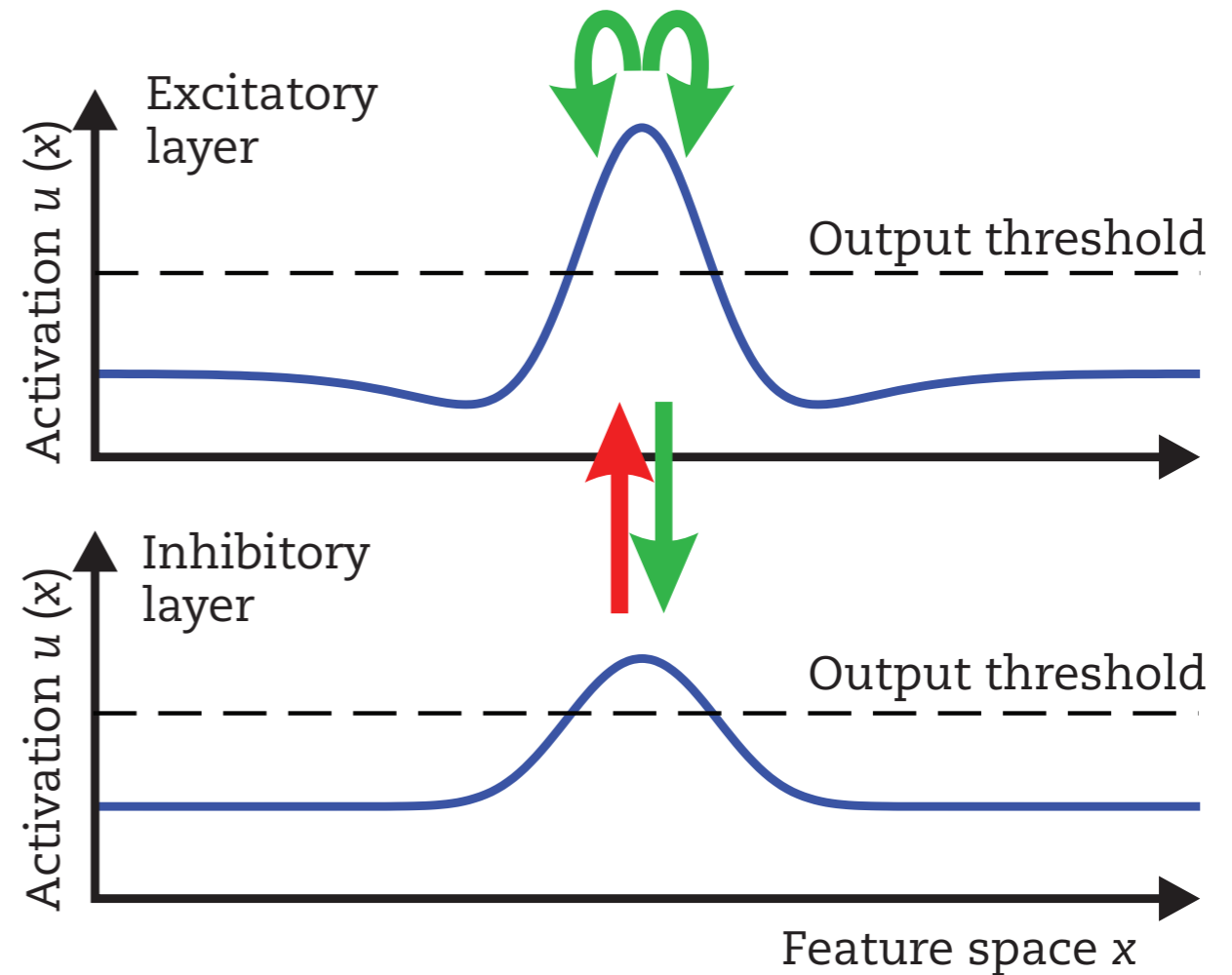

[chapter 3 of the book]

# 2 layer Amari fields

$$\tau_u \dot{u}(x, t) = -u(x, t) + h_u + s(x, t) + \int k_{uu}(x - x') g(u(x', t)) dx' - \int k_{uv}(x - x') g(v(x', t)) dx'$$

$$\tau_v \dot{v}(x, t) = -v(x, t) + h_v + \int k_{vu}(x - x') g(u(x', t)) dx'$$

with projection kernels

$$k_{uu}(x - x') = c_{uu} \cdot \exp\left(-\frac{(x - x')^2}{2\sigma_{uu}^2}\right)$$

**simulation**



# Implications

■ the fact that inhibition arises only after excitation has been induced has observable consequences in the time course of decision making:

- initially input-dominated
- early excitatory interaction
- late inhibitory interaction

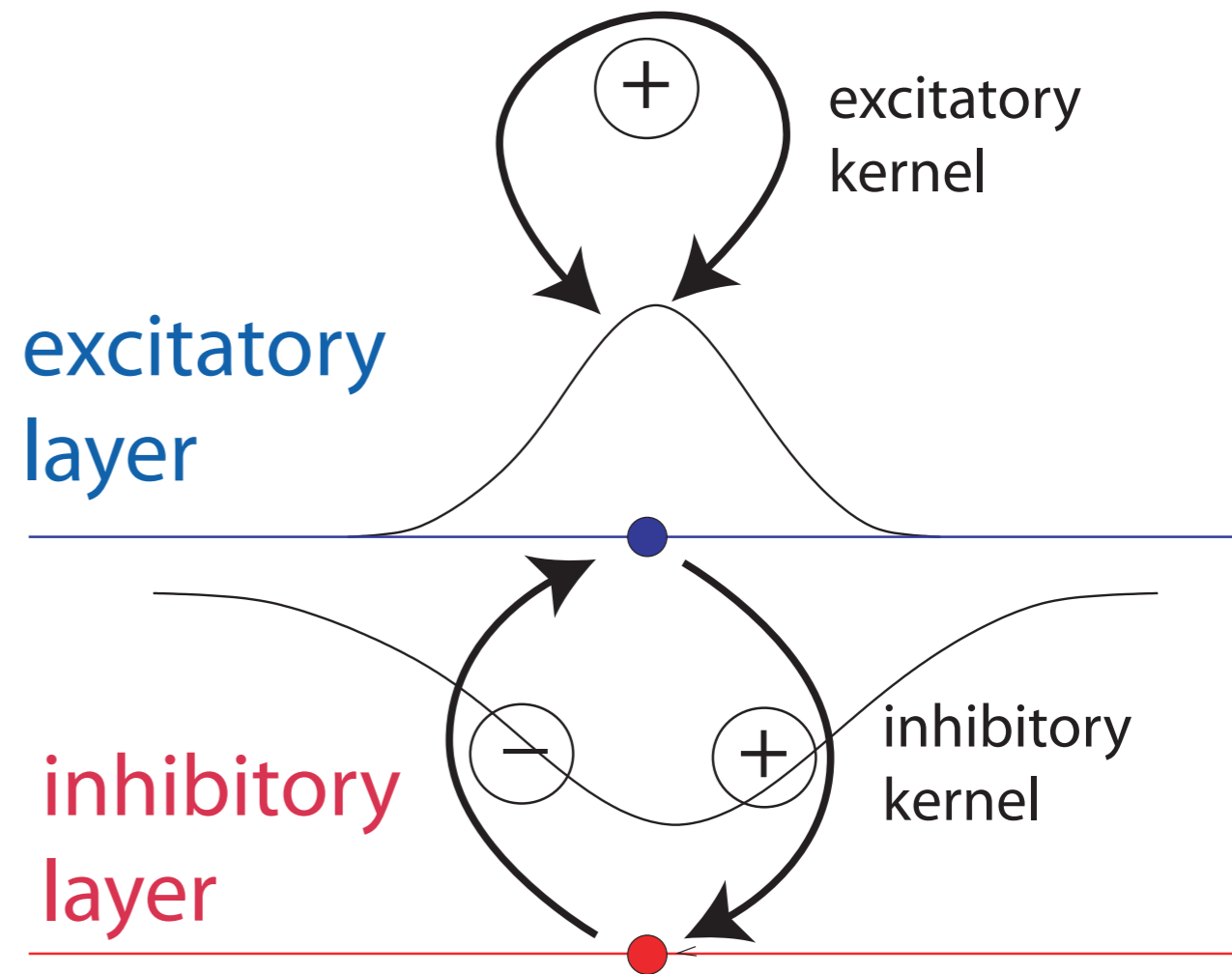

# time course of selection

intermediate: dominated by excitatory interaction

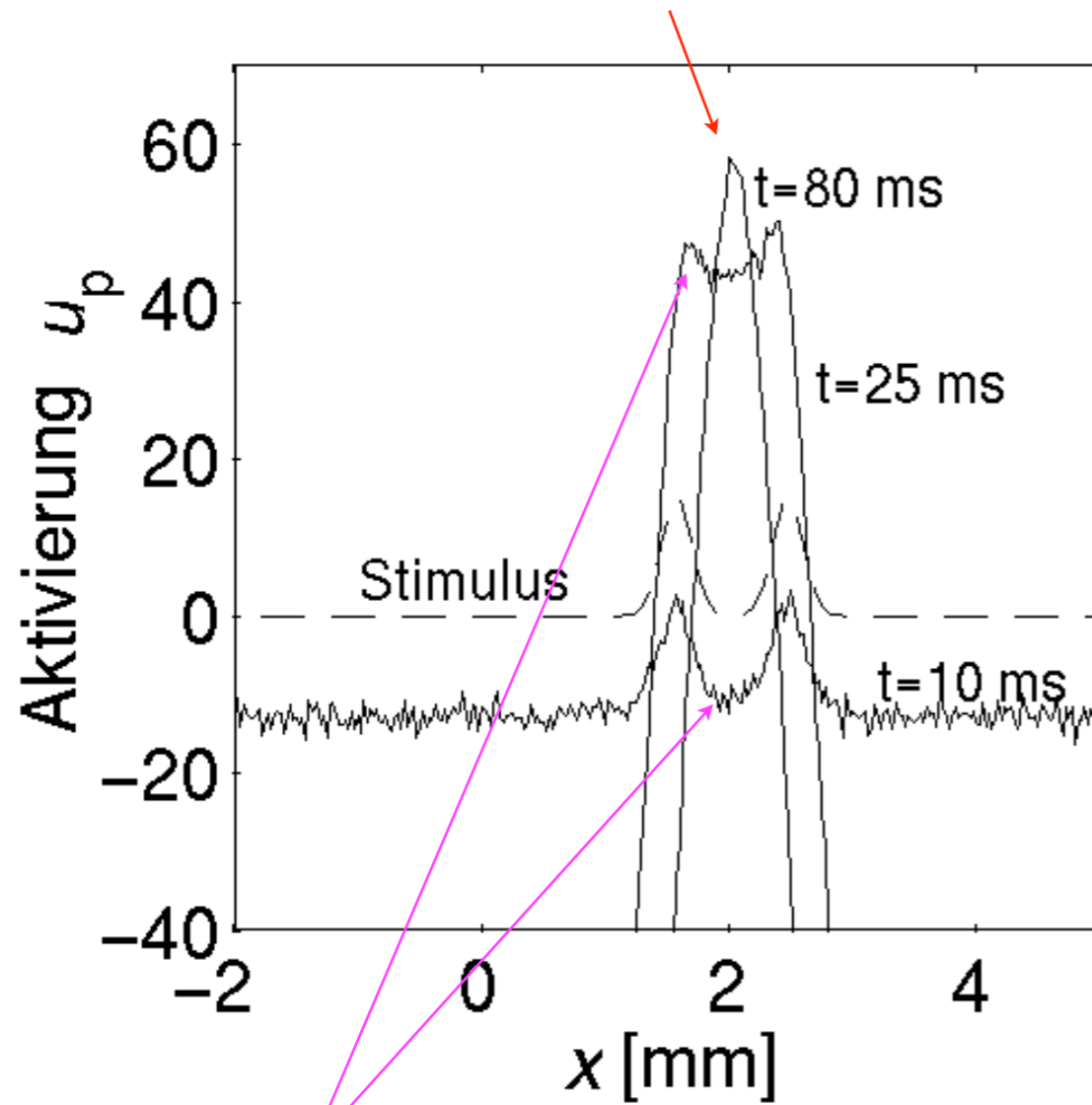

early: input driven

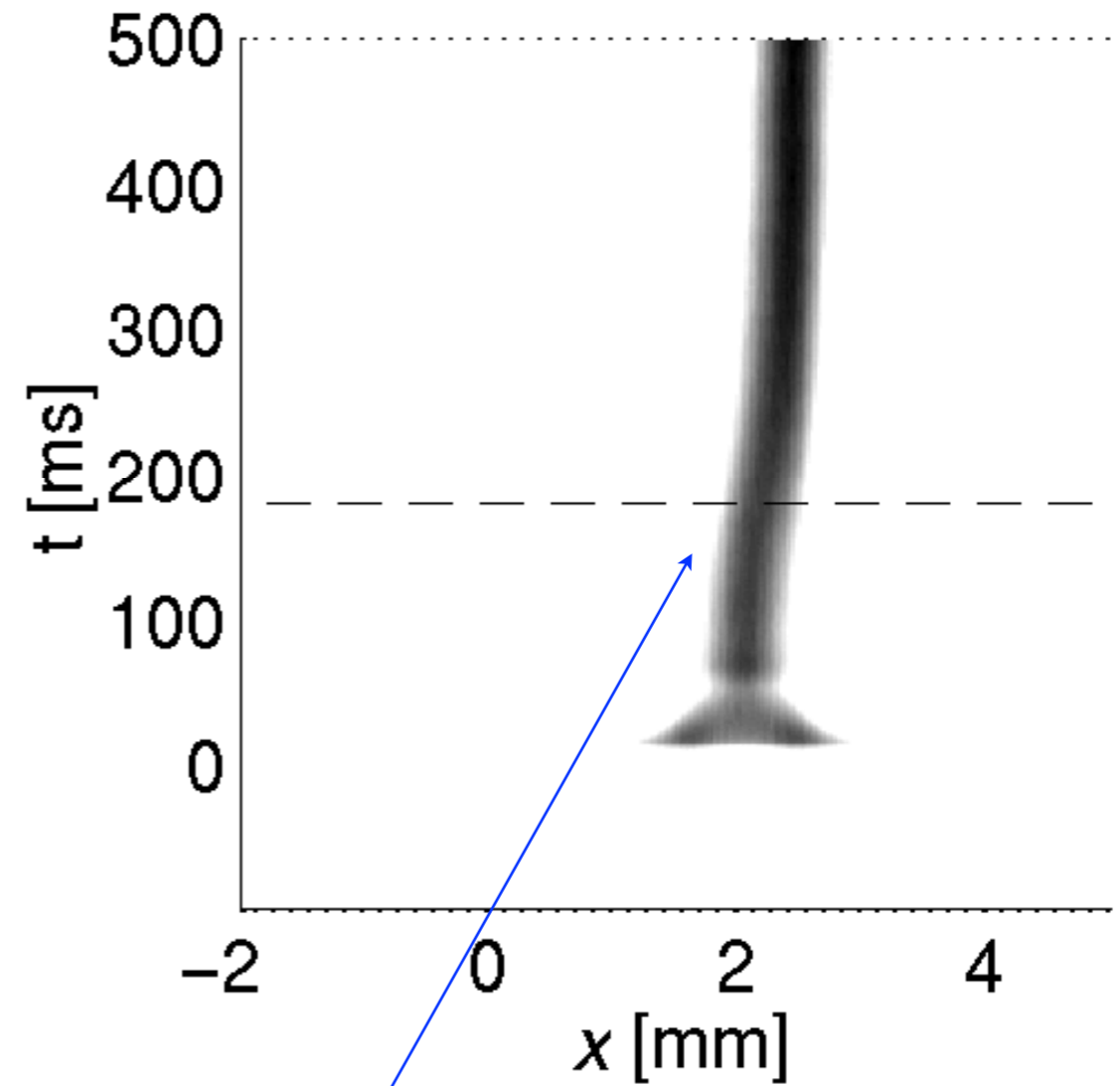

late: inhibitory interaction drives selection

**=> early fusion, late selection**

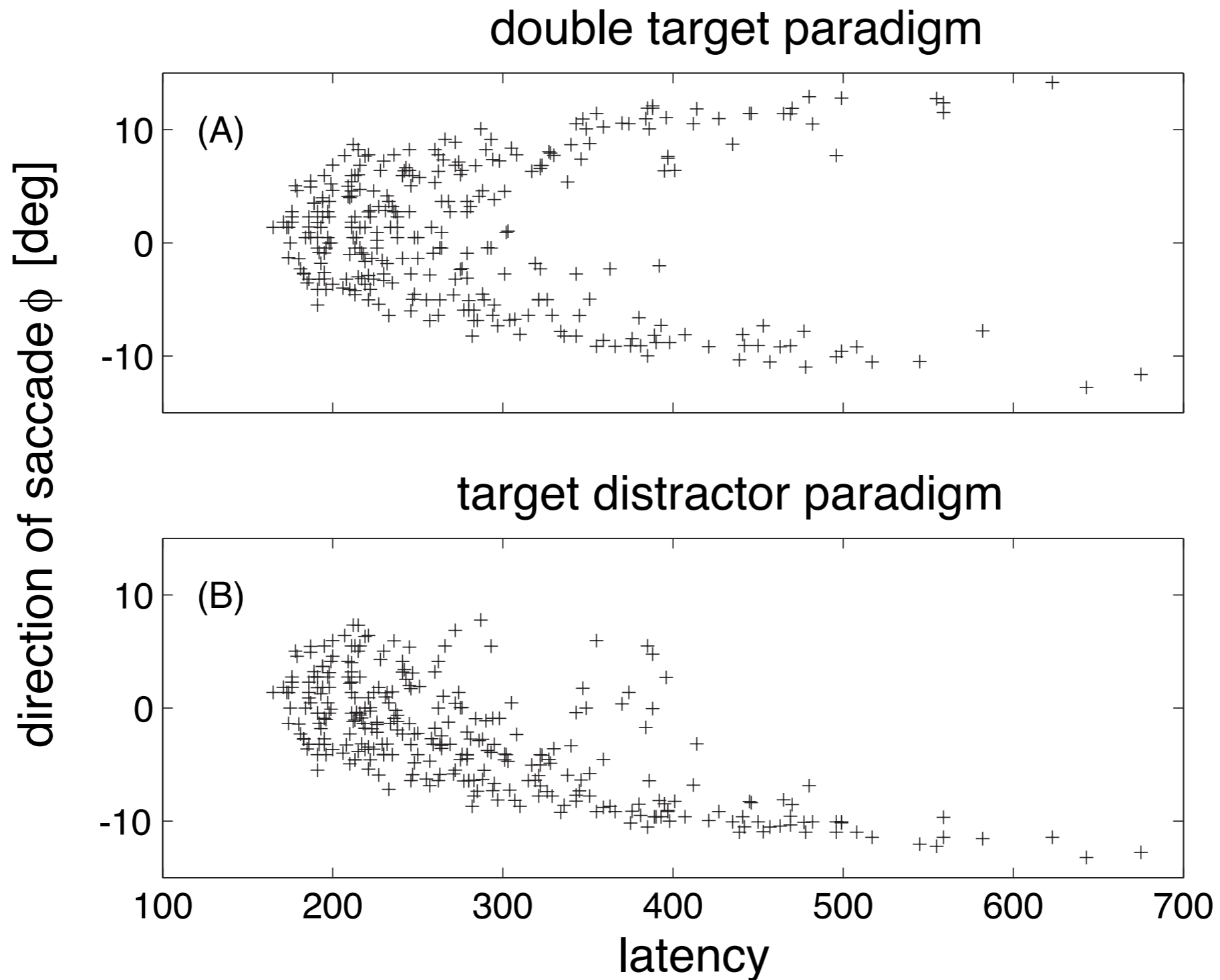

[figure: Wilimzig, Schneider, Schöner, Neural Networks, 2006]

# fixation and selection

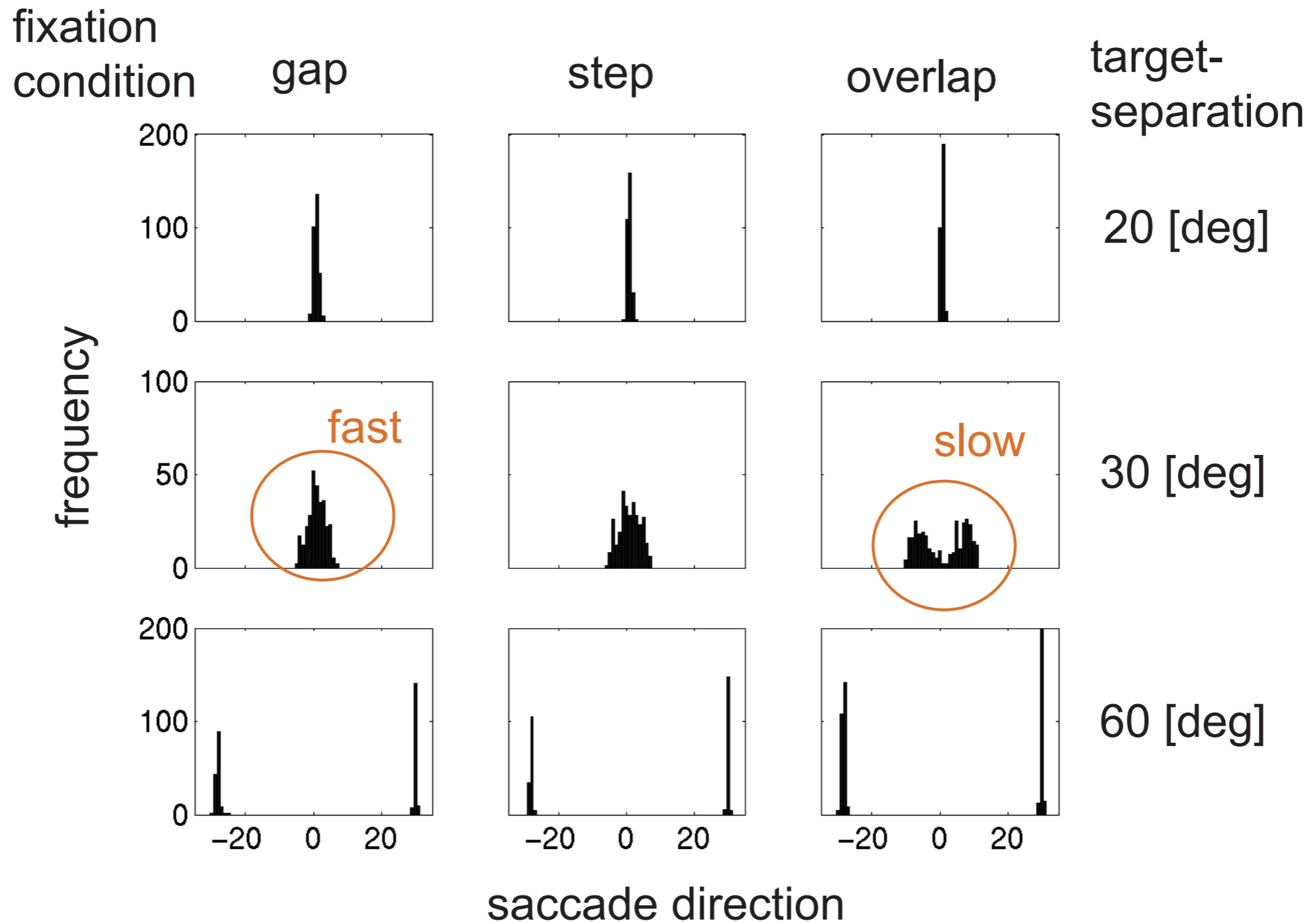

[figure: Wilimzig, Schneider, Schöner, Neural Networks, 2006]

# 2 layer fields afford oscillations

- => simulation
- (oscillatory states for enhanced coupling among fields)
- (generic nature of oscillations)

# studying selection decisions in the laboratory

- using an imperative signal...

# reaction time (RT) paradigm

imperative  
signal=  
go signal

response

task set

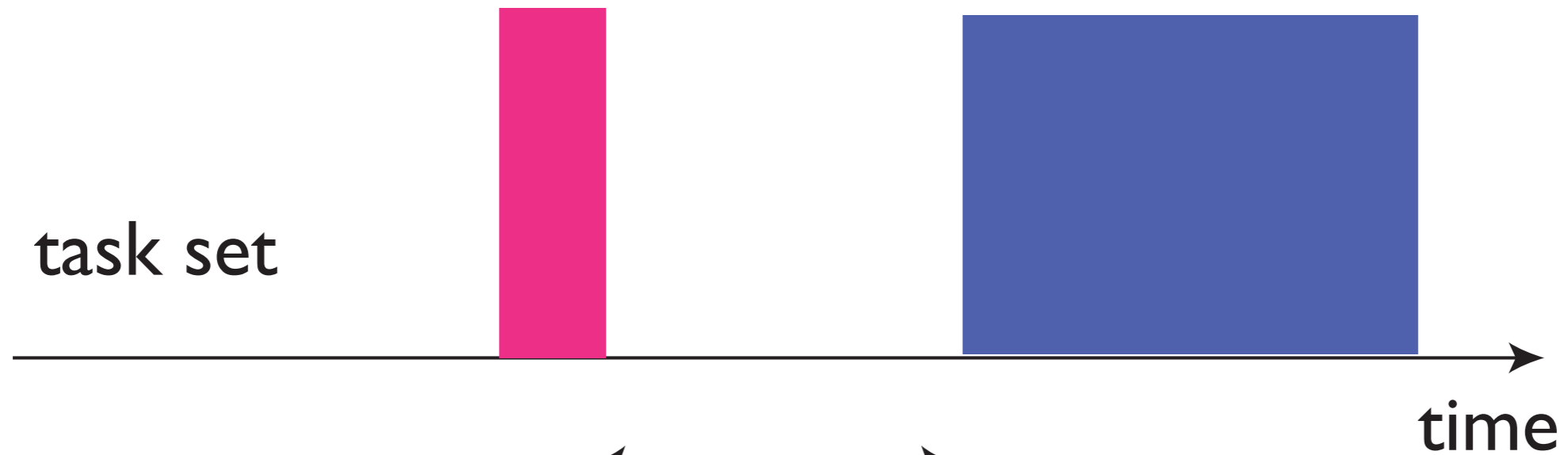

# the task set

- is the critical factor in such studies of selection: which perceptual/action alternative/choices are available...
  - e.g., how many choices
  - e.g., how likely is each choice
  - e.g., how “easy” are the choices to recognize/perform
- because the task set is known to the participant prior to the presentation of the imperative signal, one may think of the task set as a “preshaping” of the underlying representation (pre=before the decision)



# notion of preshape

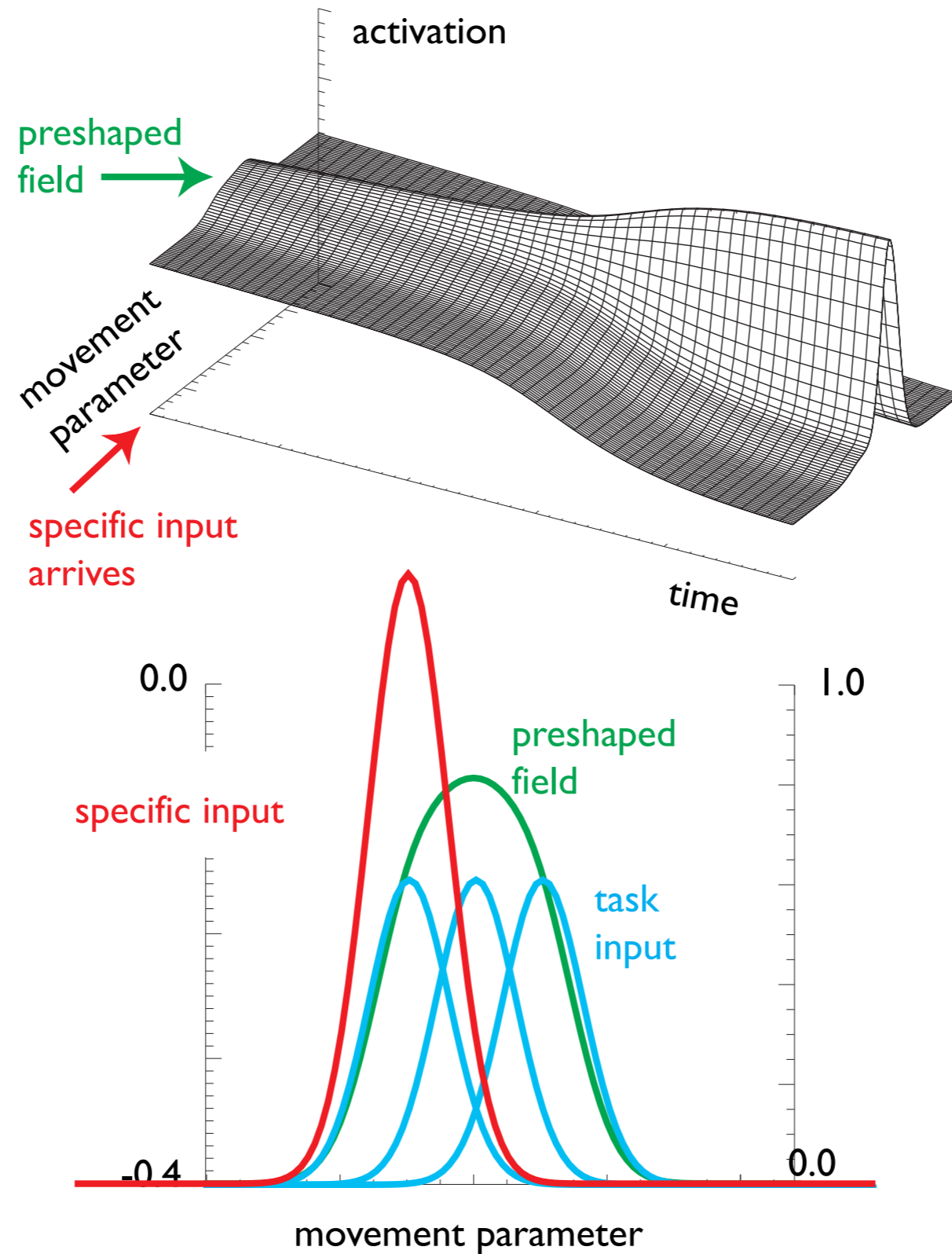

# weak preshape in selection

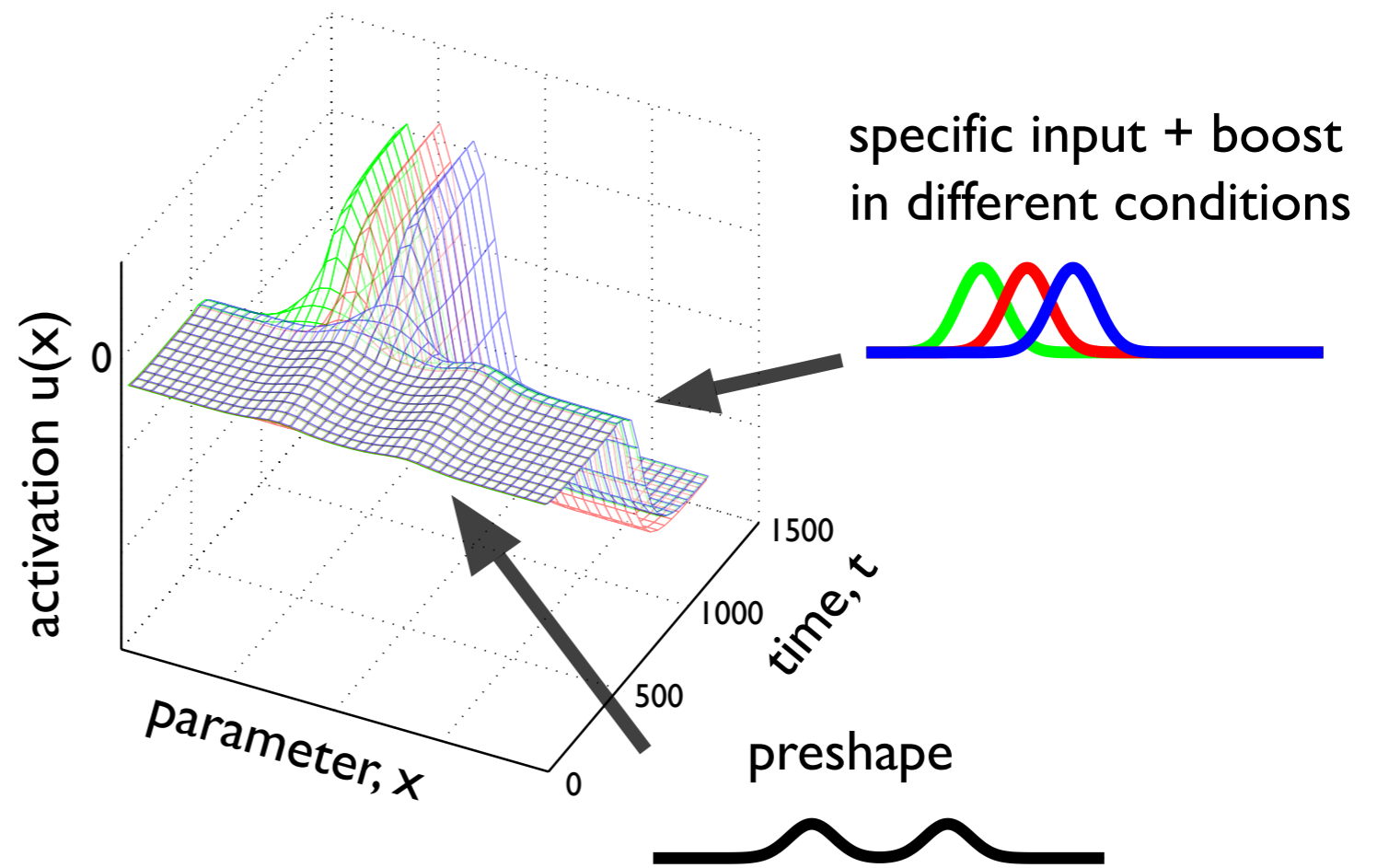

- specific (imperative) input dominates and drives detection instability

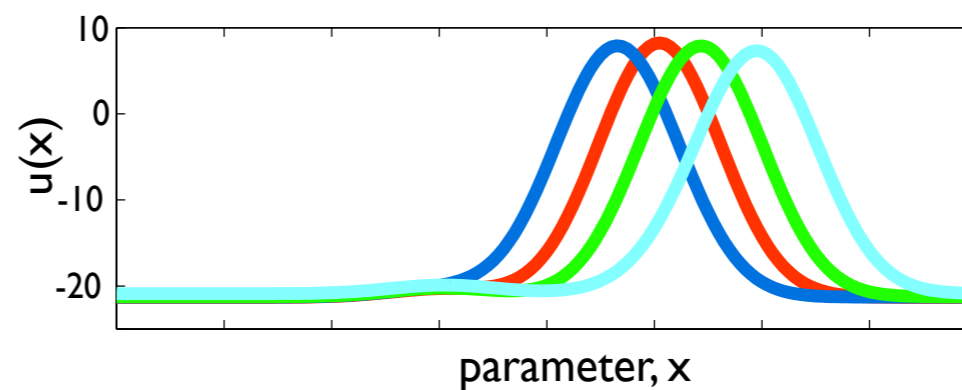
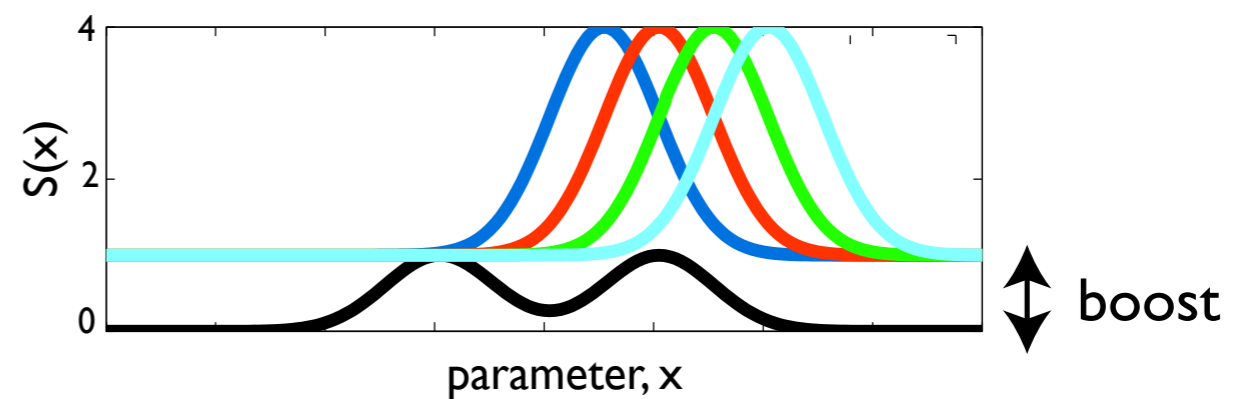

# using preshape to account for classical RT data

- Hick's law: RT increases with the number of choices

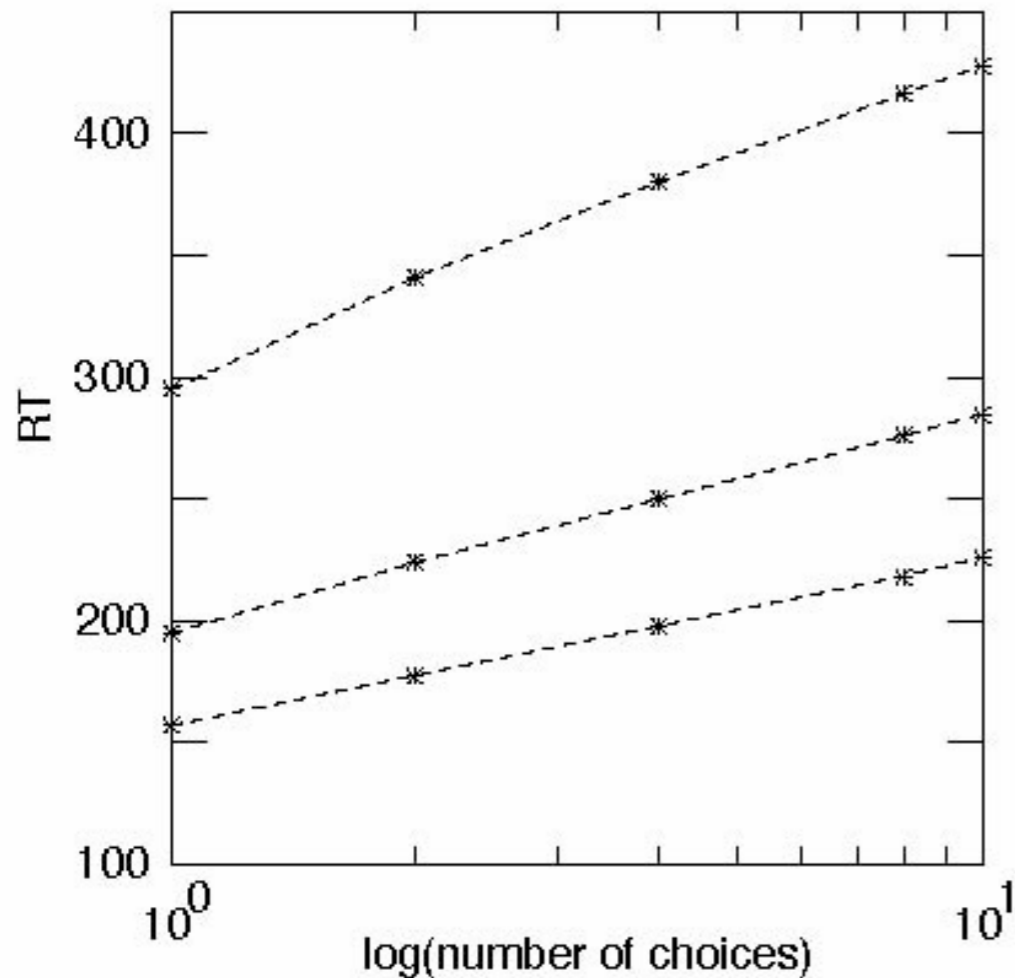

[Erlhagen, Schöner, Psych Rev 2002]

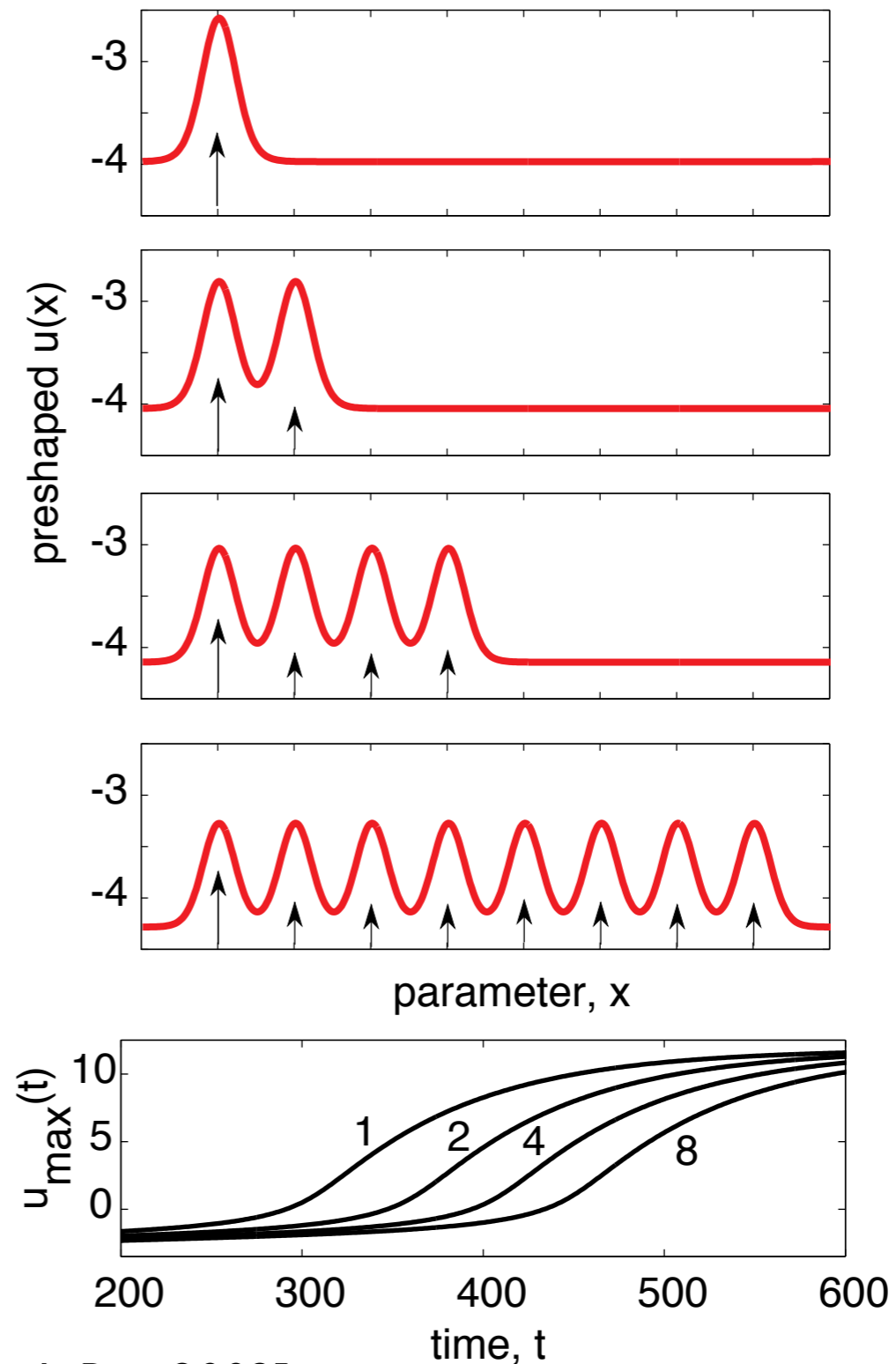

# metric effect

- predict faster response times for metrically close than for metrically far choices

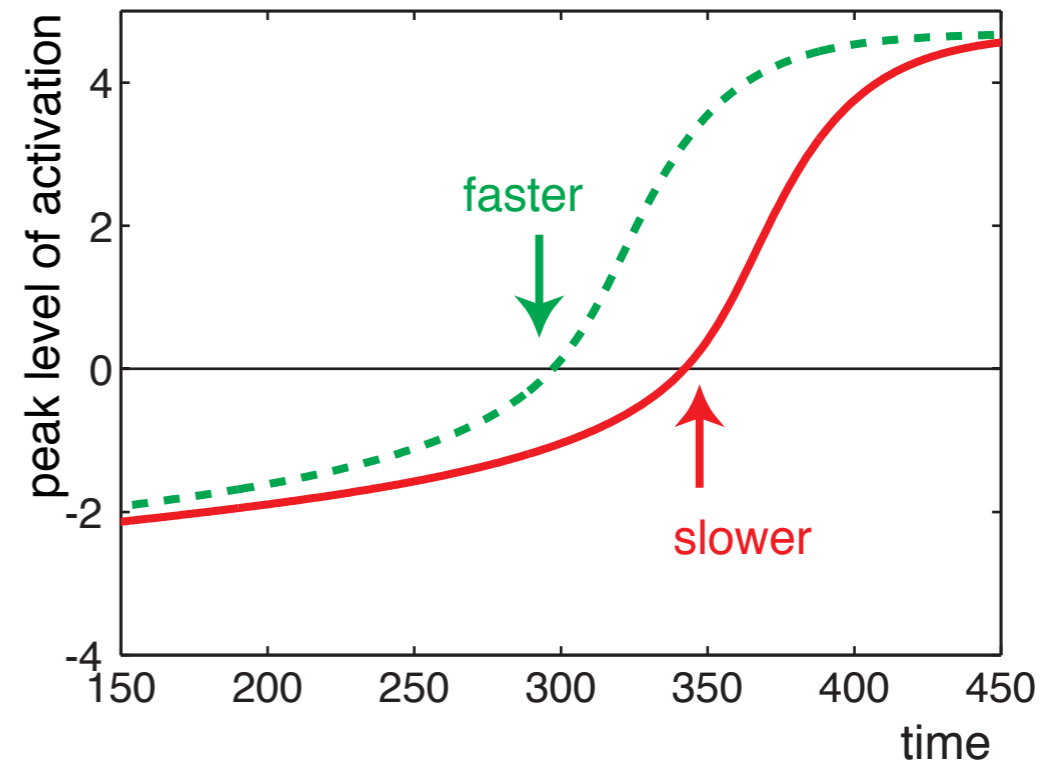
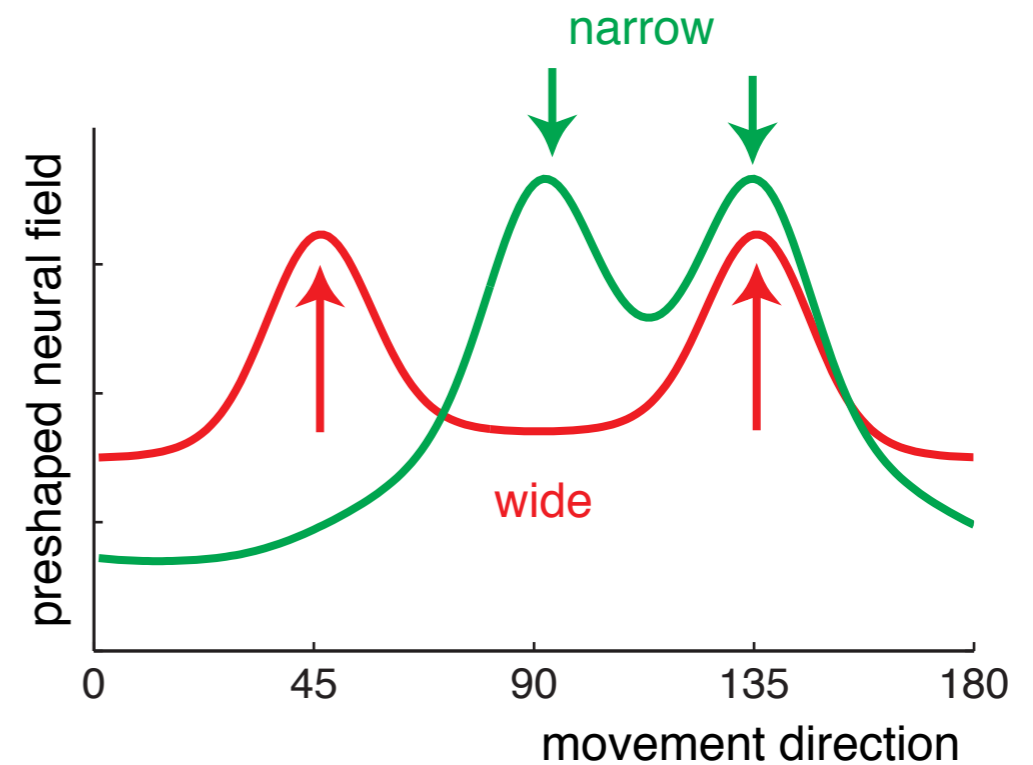

[from Schöner, Kopecz, Erlhagen, 1997]

# experiment: metric effect

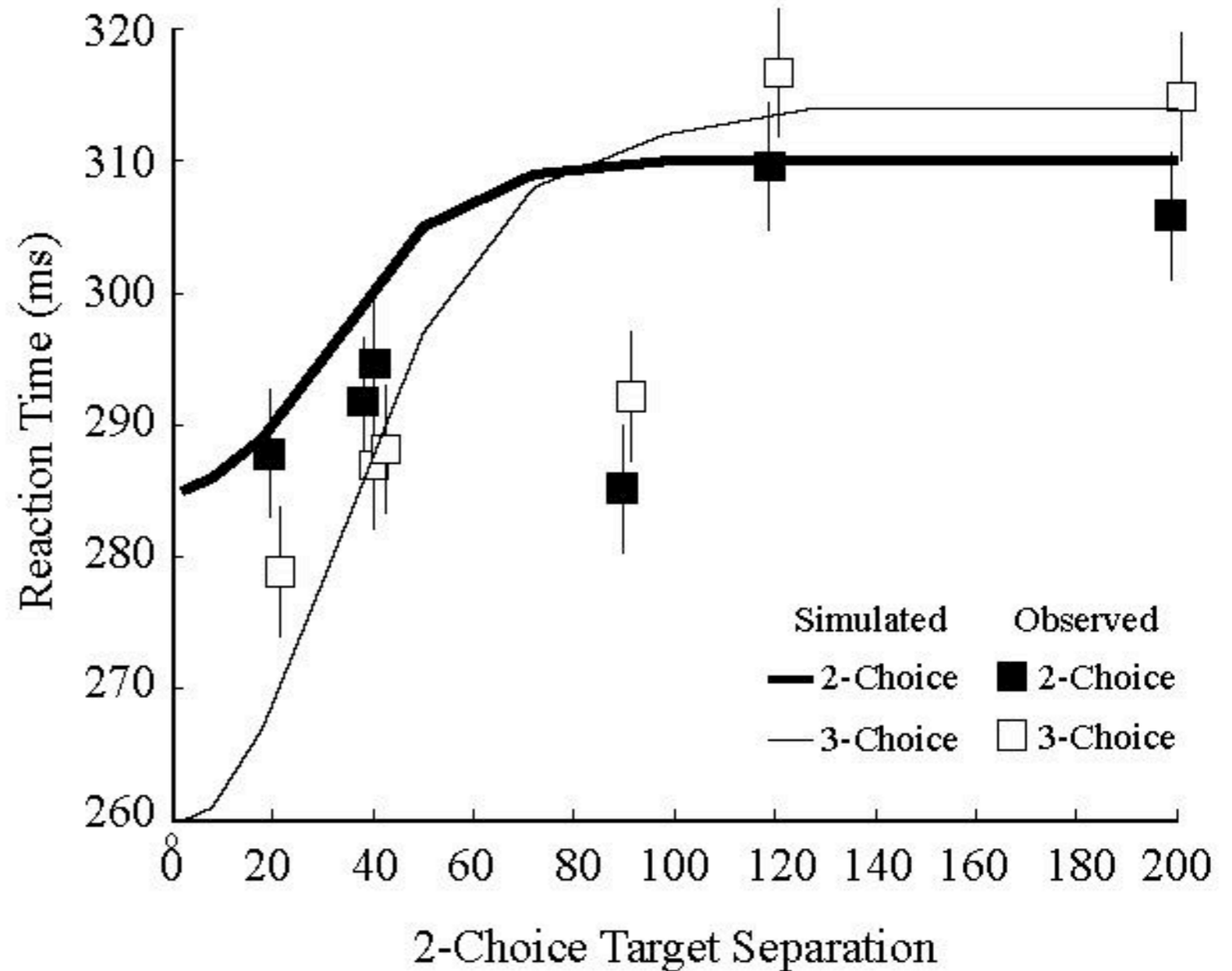
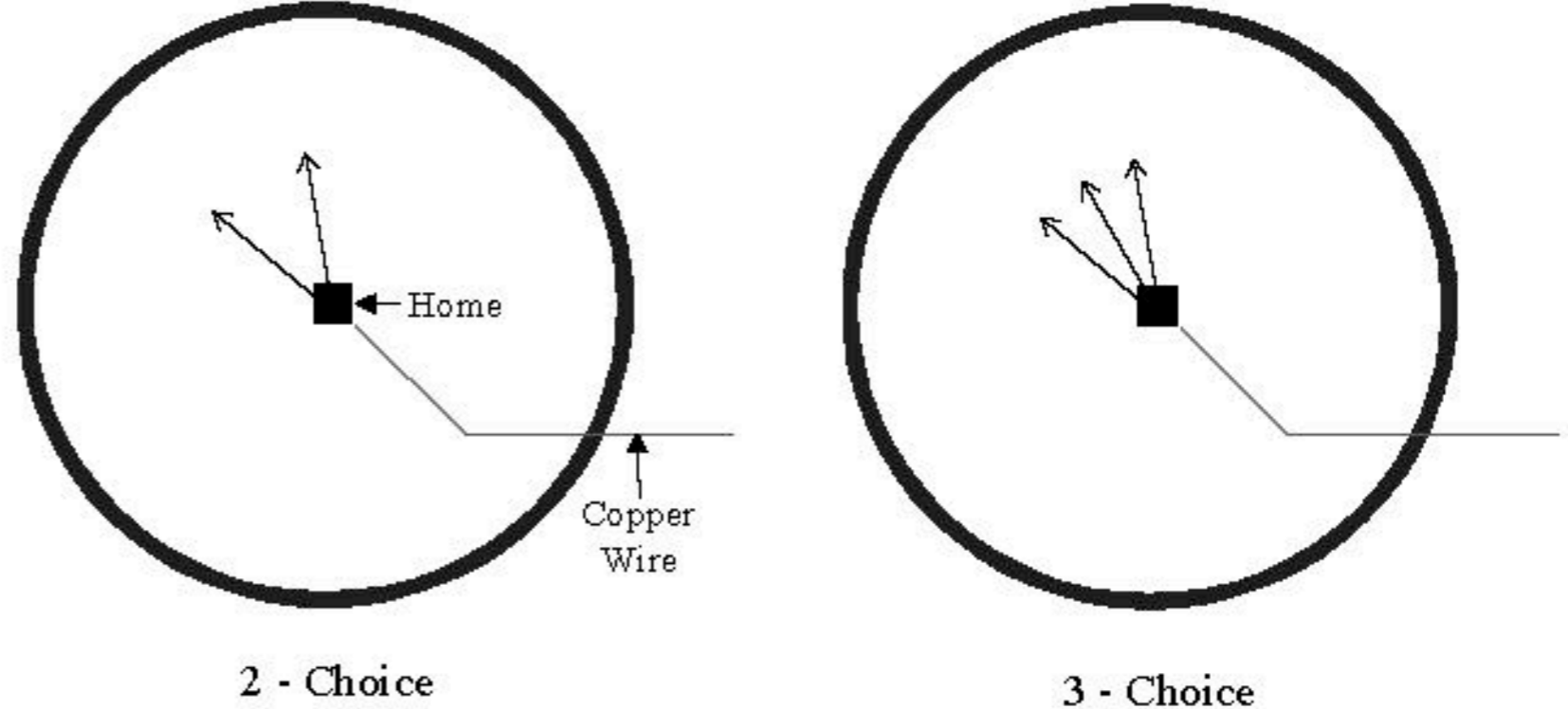

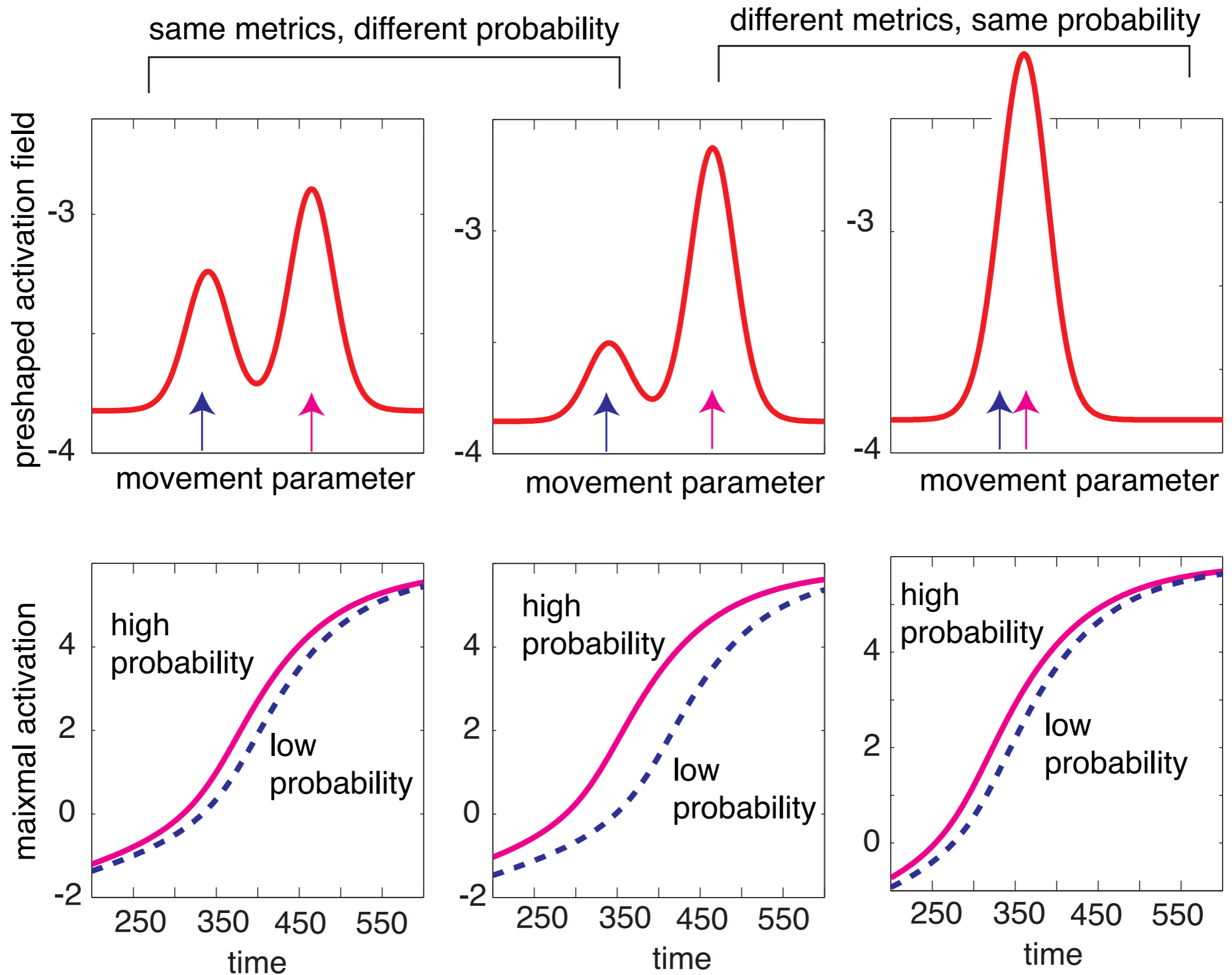

[from Erlhagen, Schöner: Psych. Rev. 2002]

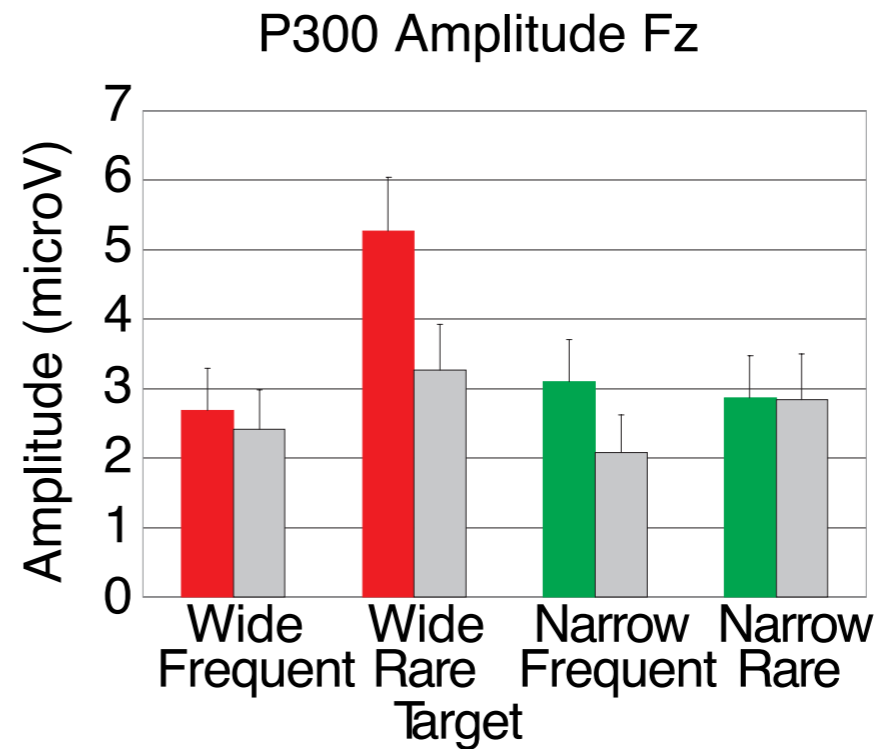
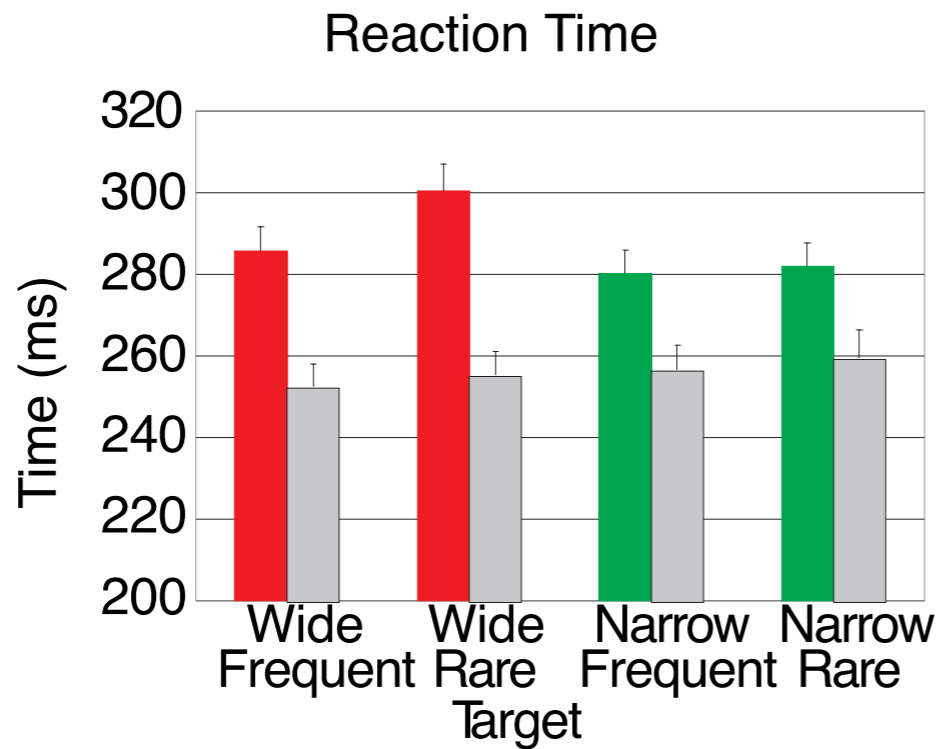
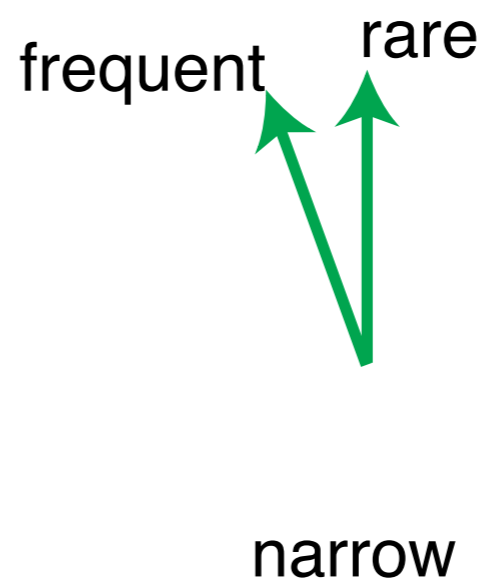
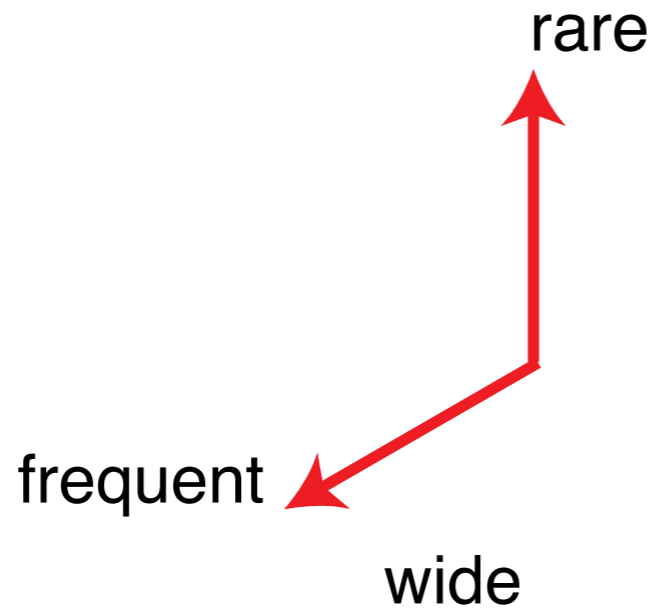

[from McDowell, Jeka, Schöner, Hatfield, 2002]

# detection-selection: overcoming fixation

- detection can be like selection: initiating an action means terminating the non-action=fixation or posture
- example: saccade initiation

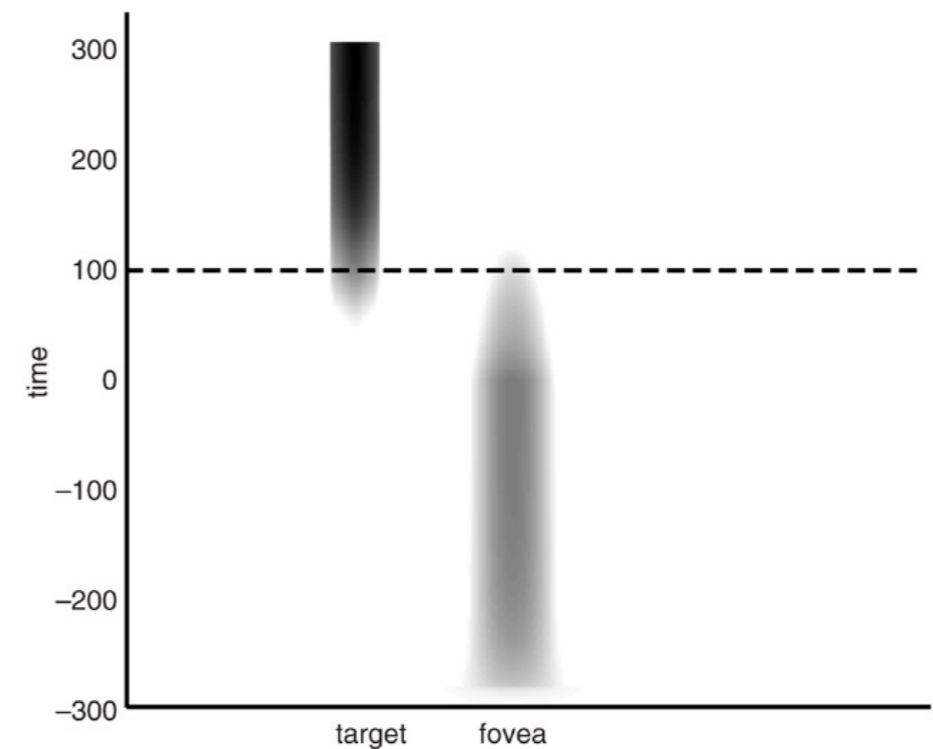
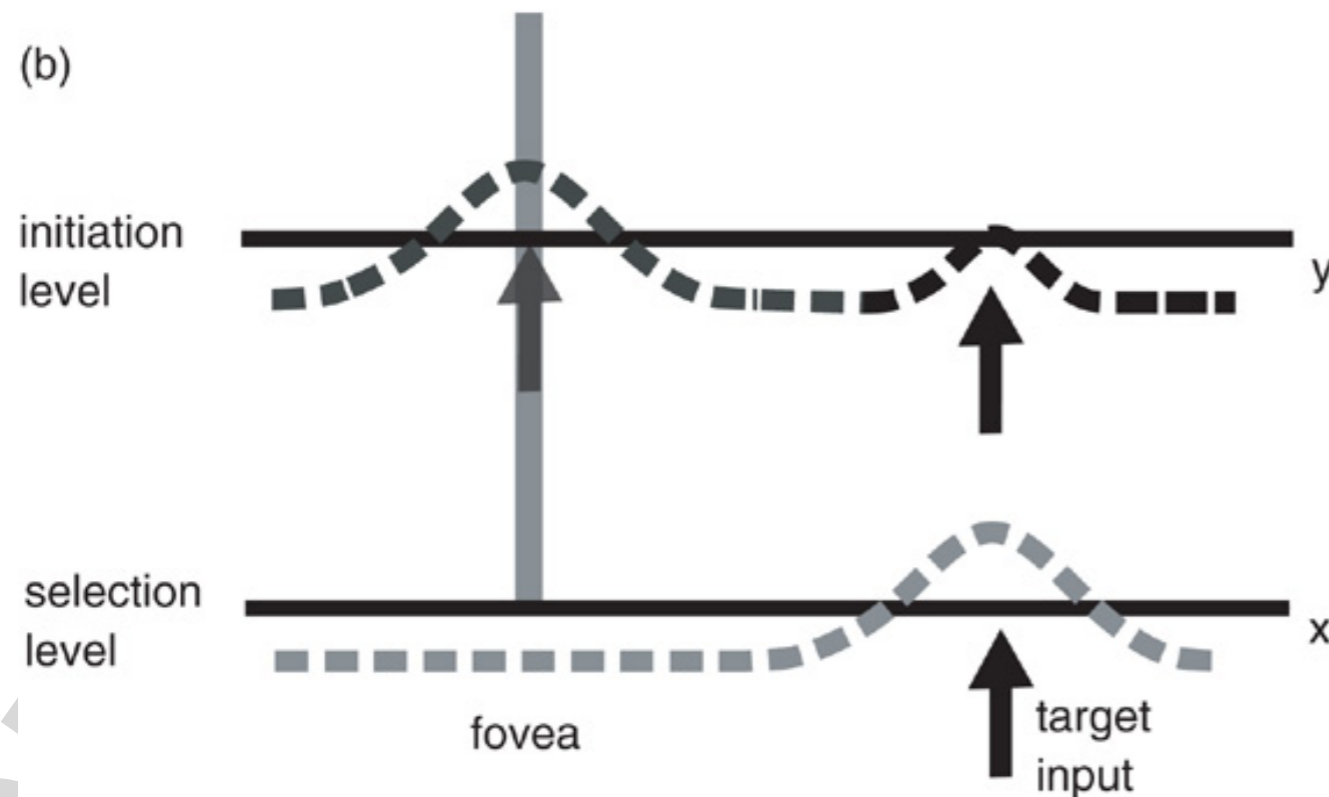

[Wilimzig, Schneider, Schöner, 2006]



# initiation vs. fixation

- such models account for the gap-step-overlap effect

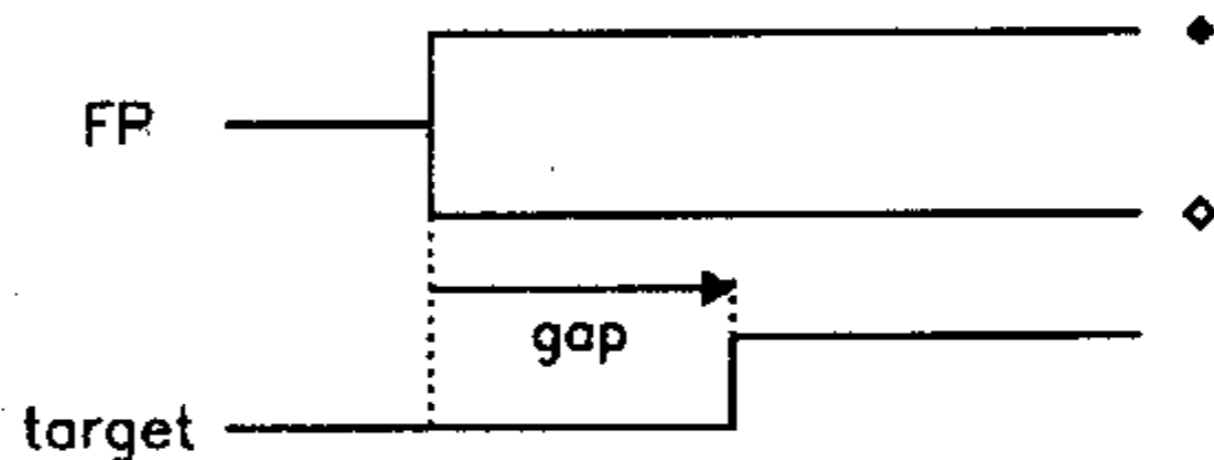
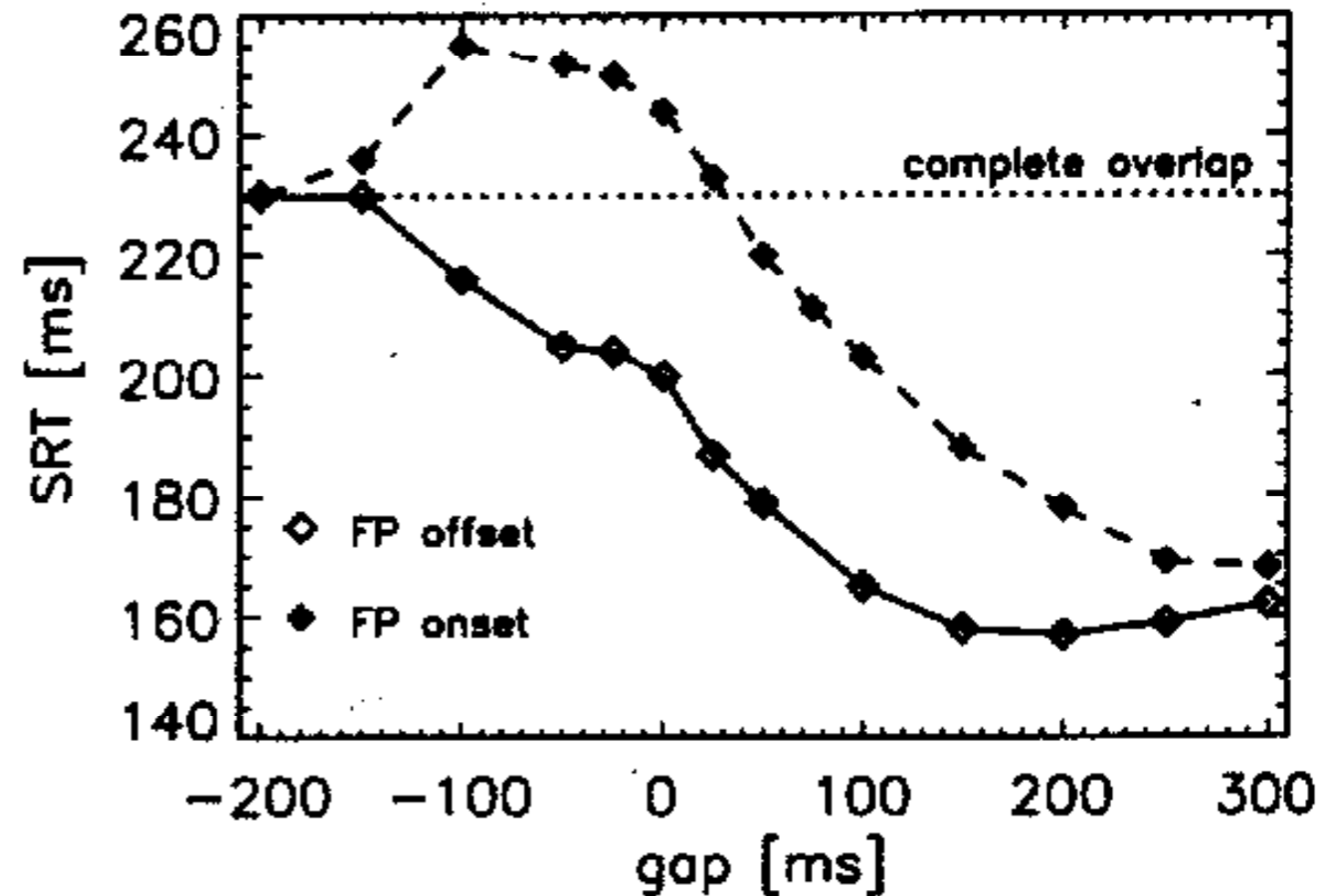

[Kopecz, 95]

# boost-induced detection instability

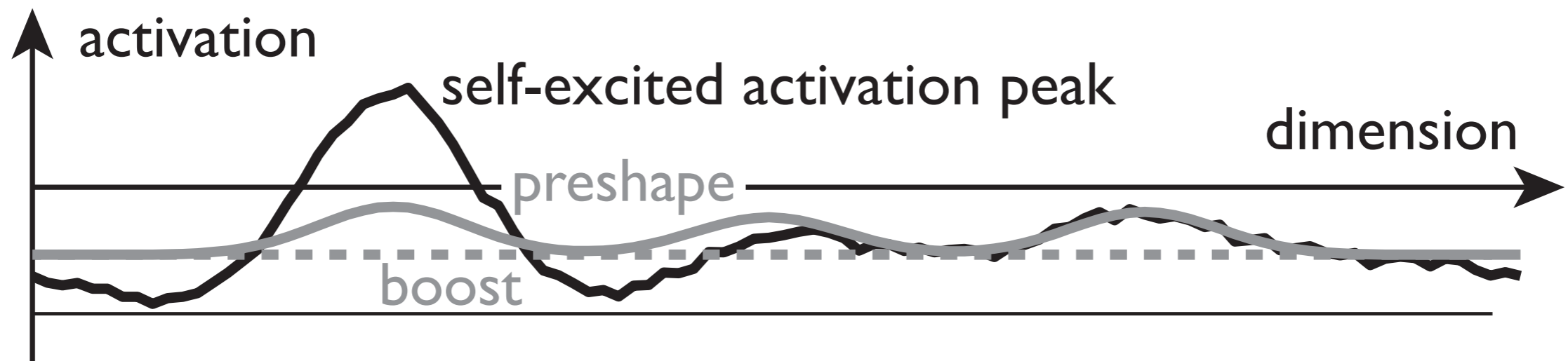
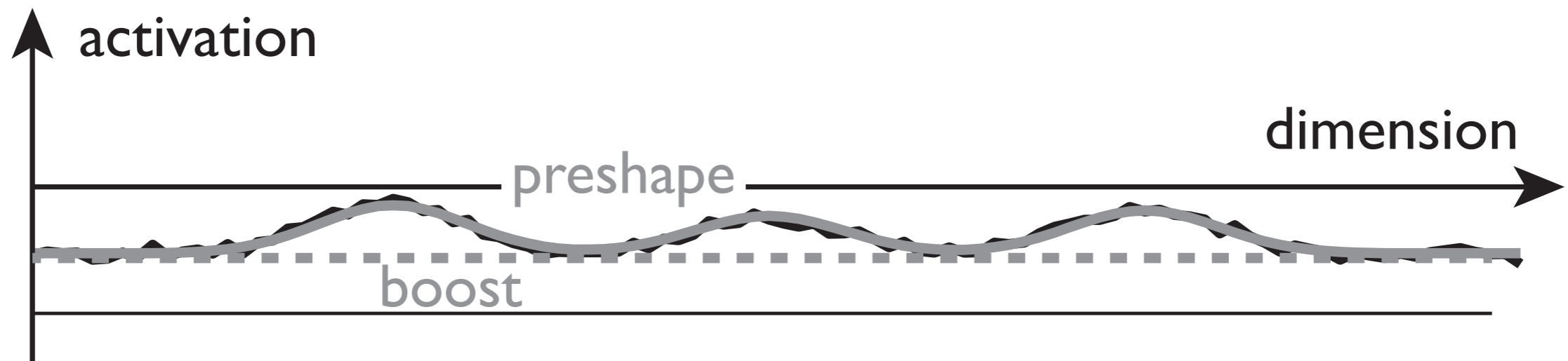
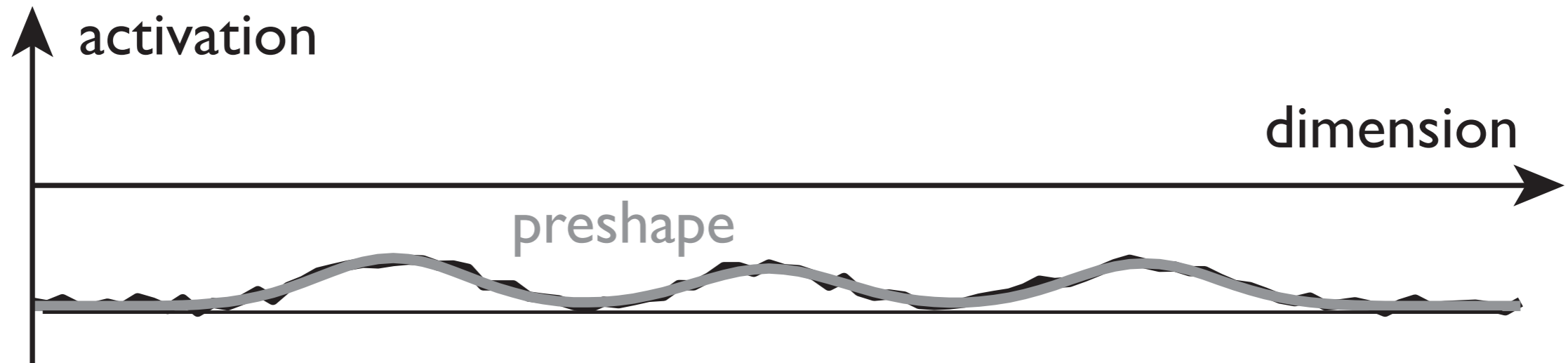

# boost-driven detection instability

- inhomogeneities in the field existing prior to a signal/stimulus that leads to a macroscopic response="preshape"
- the boost-driven detection instability amplifies preshape into macroscopic selection decisions

# ... emergence of categories?

- if we understand, how such inhomogeneities come about, we understand the emergence of categories...

this supports  
categorical  
behavior

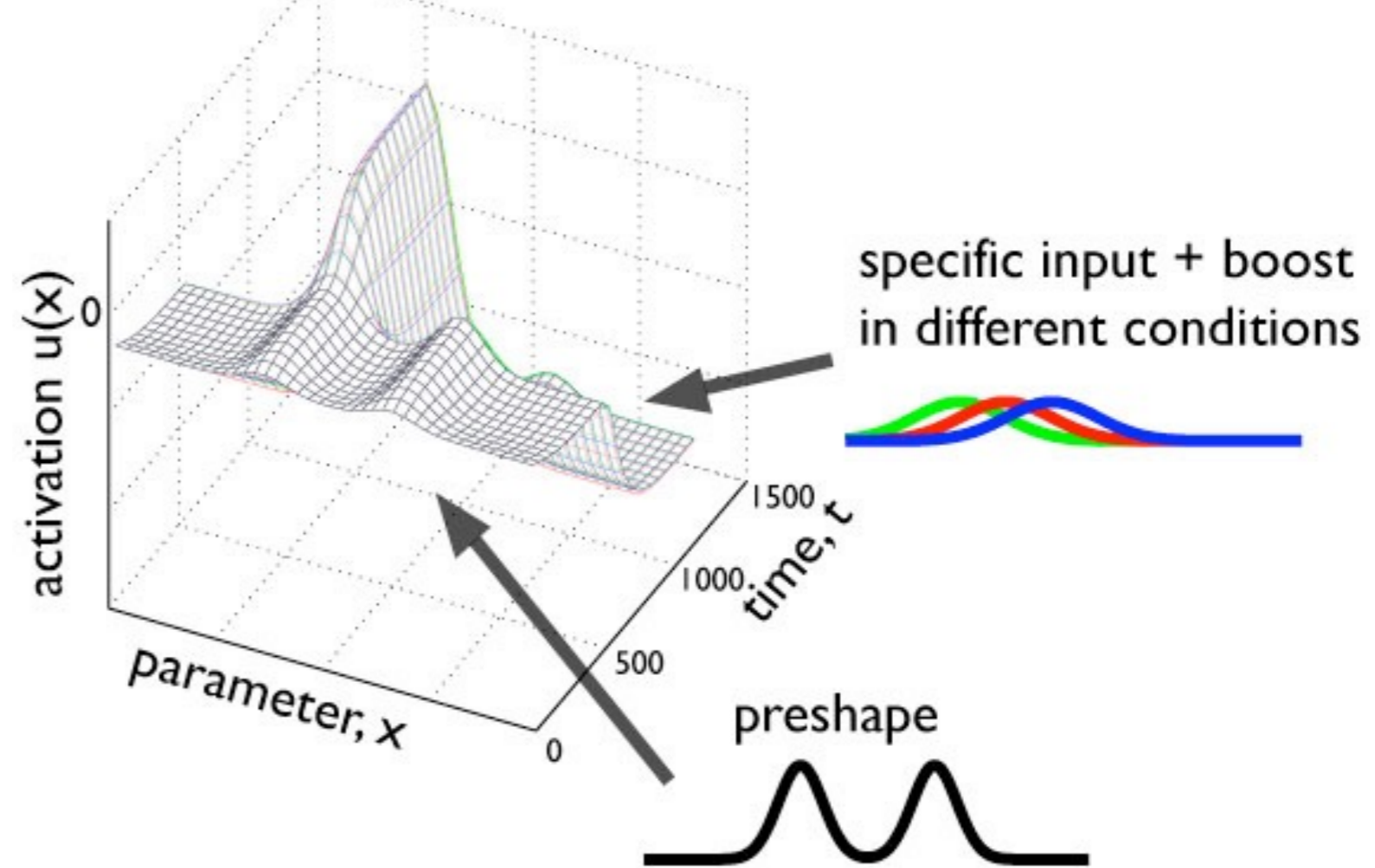

■ when preshape  
dominates

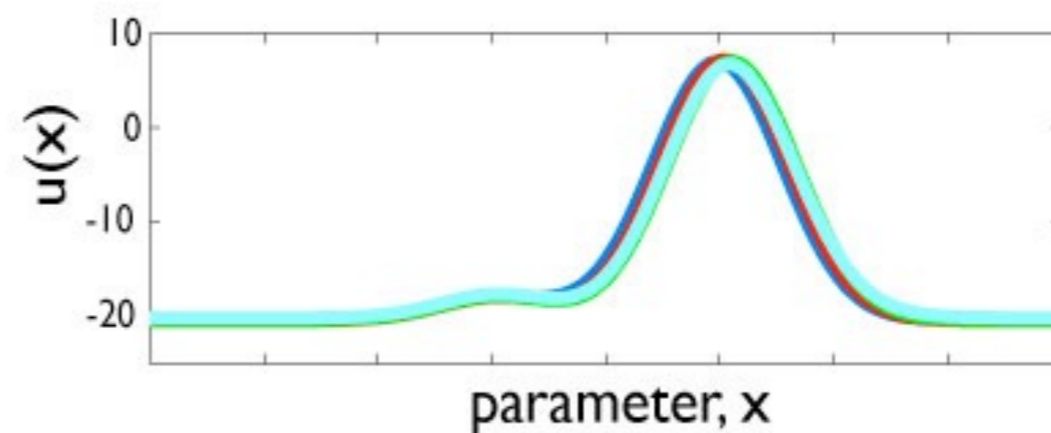
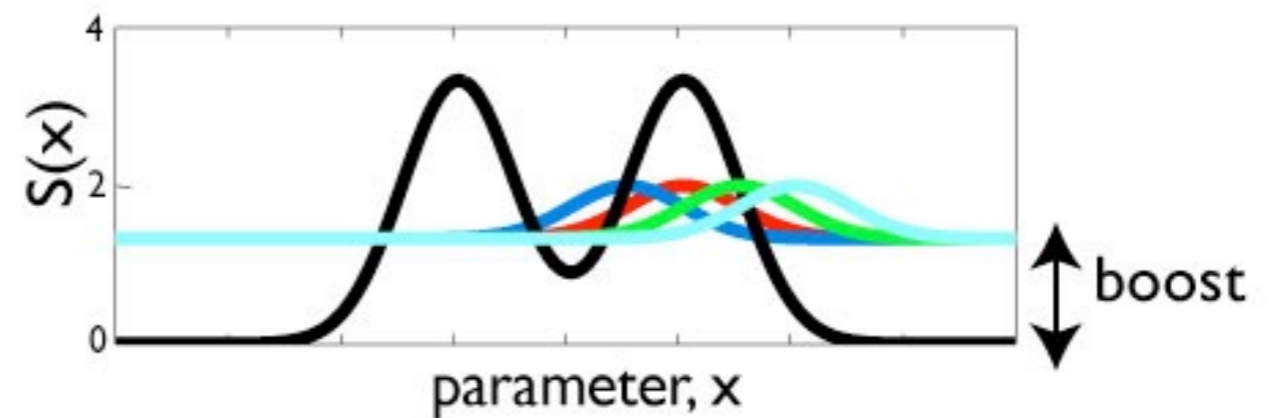

[Wilimzig, Schöner, 2006]

# categorical responding

- based on categorical memory trace and boost-driven detection instability

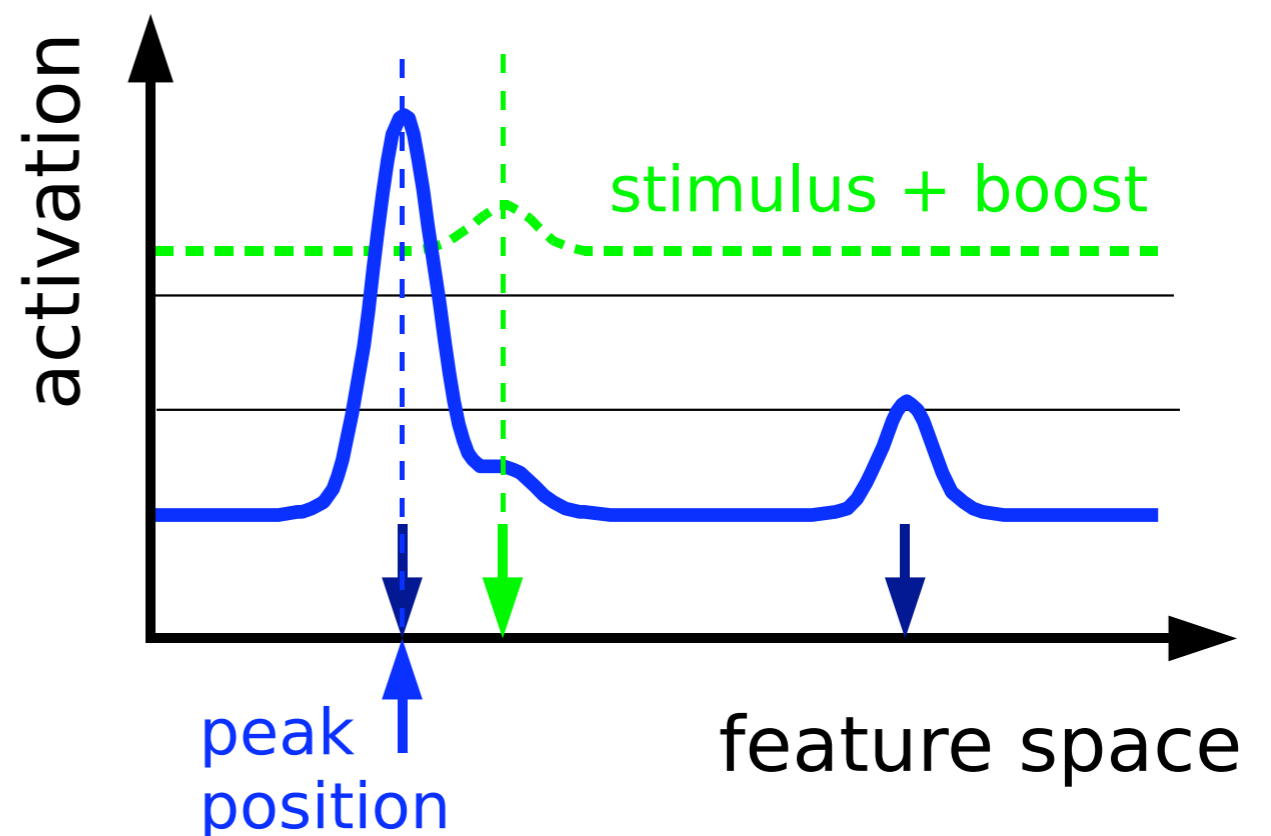
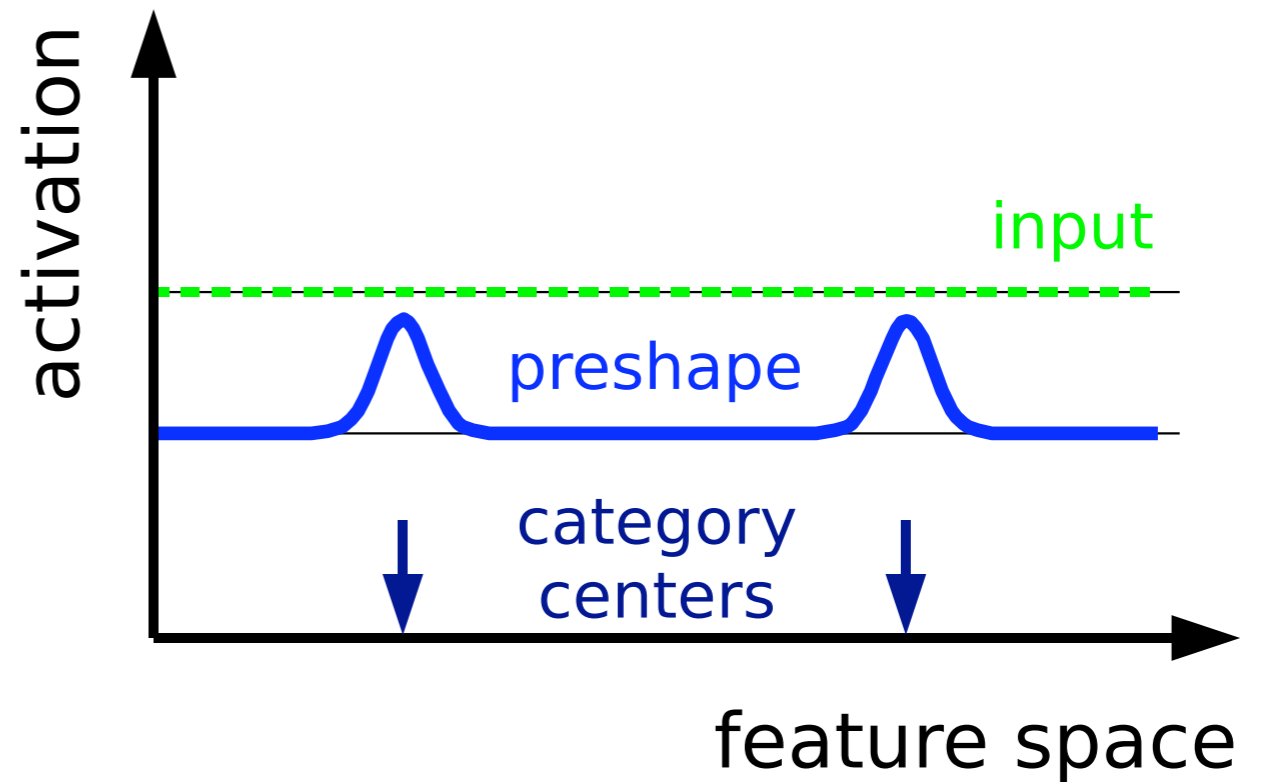

# distance effect

- common in categorical tasks... e.g., decide which of two sticks is longer => RT is larger when sticks are more similar in length (1930s')

# interaction metrics-probability

- opposite to that predicted for input-driven instabilities:
- metrically close choices show larger effect of probability

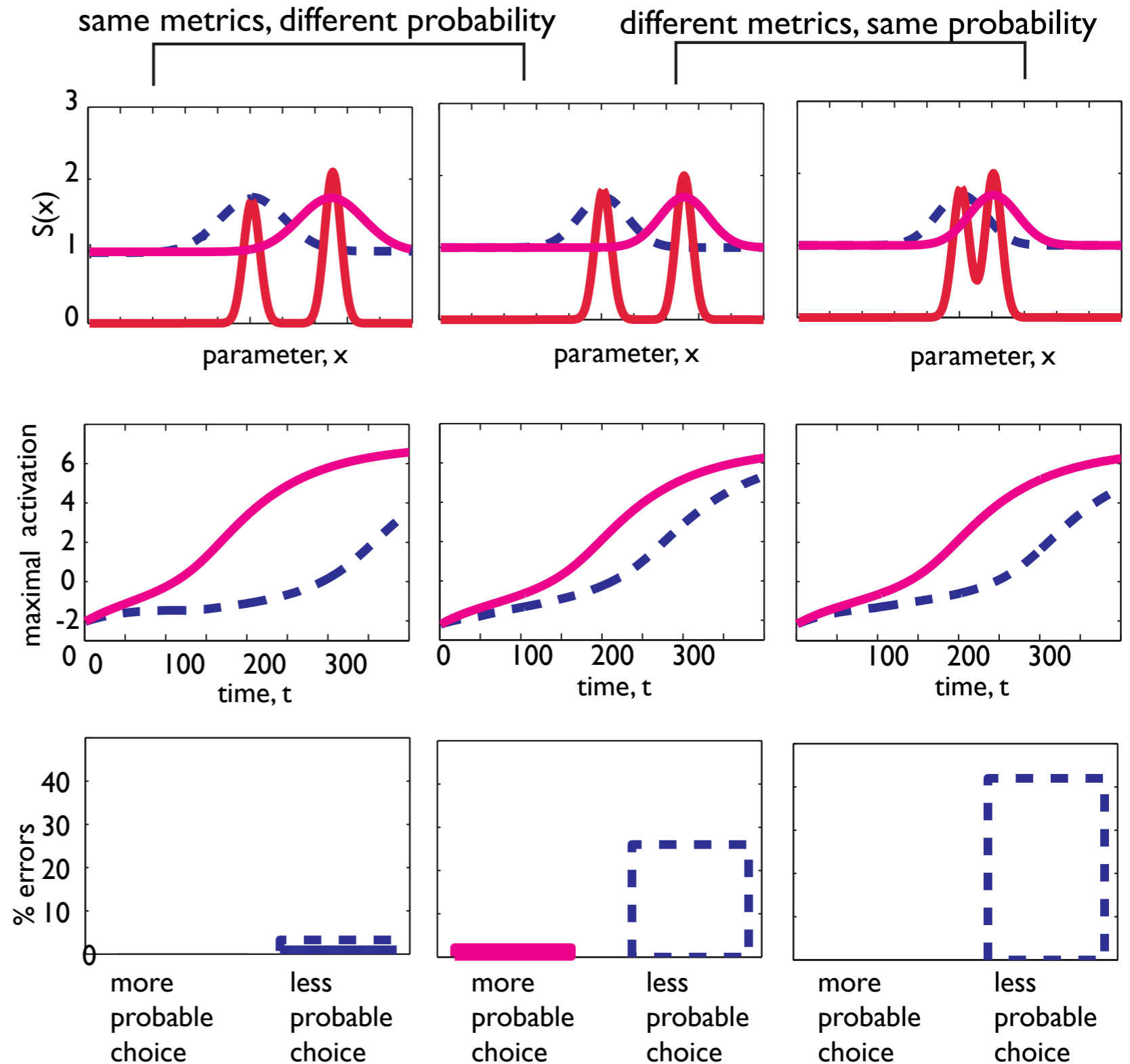



# Time course of selection decisions: Behavioral evidence for the graded and continuous evolution of decision

timed movement  
initiation paradigm

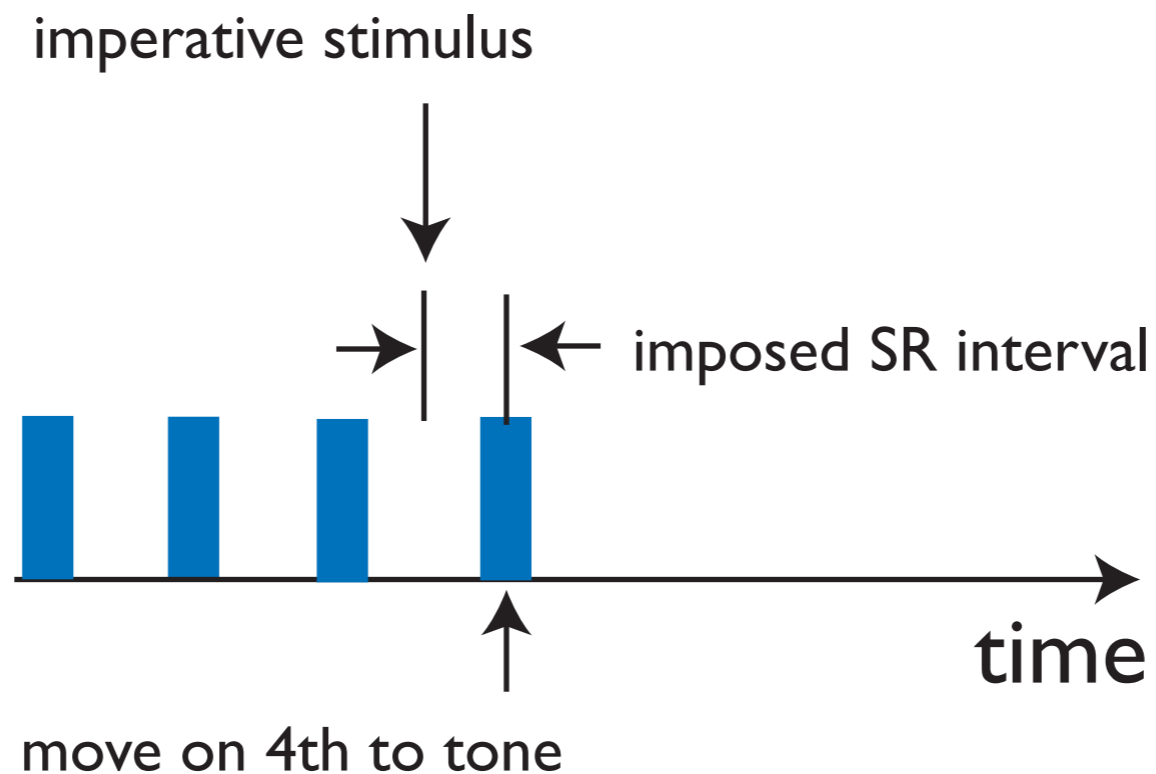

[Ghez and colleagues, 1988 to 1990's]

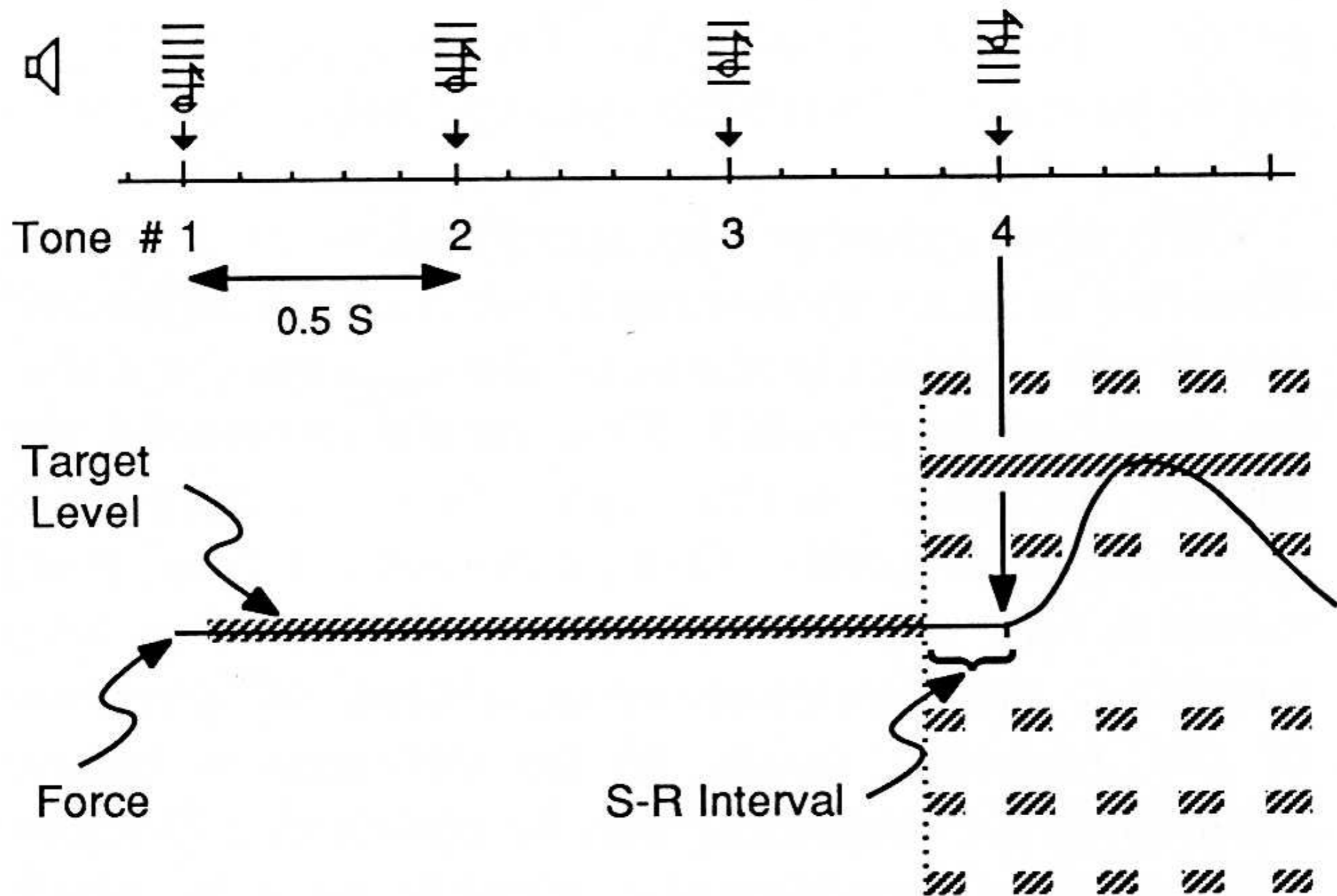

[Favilla et al. 1989]

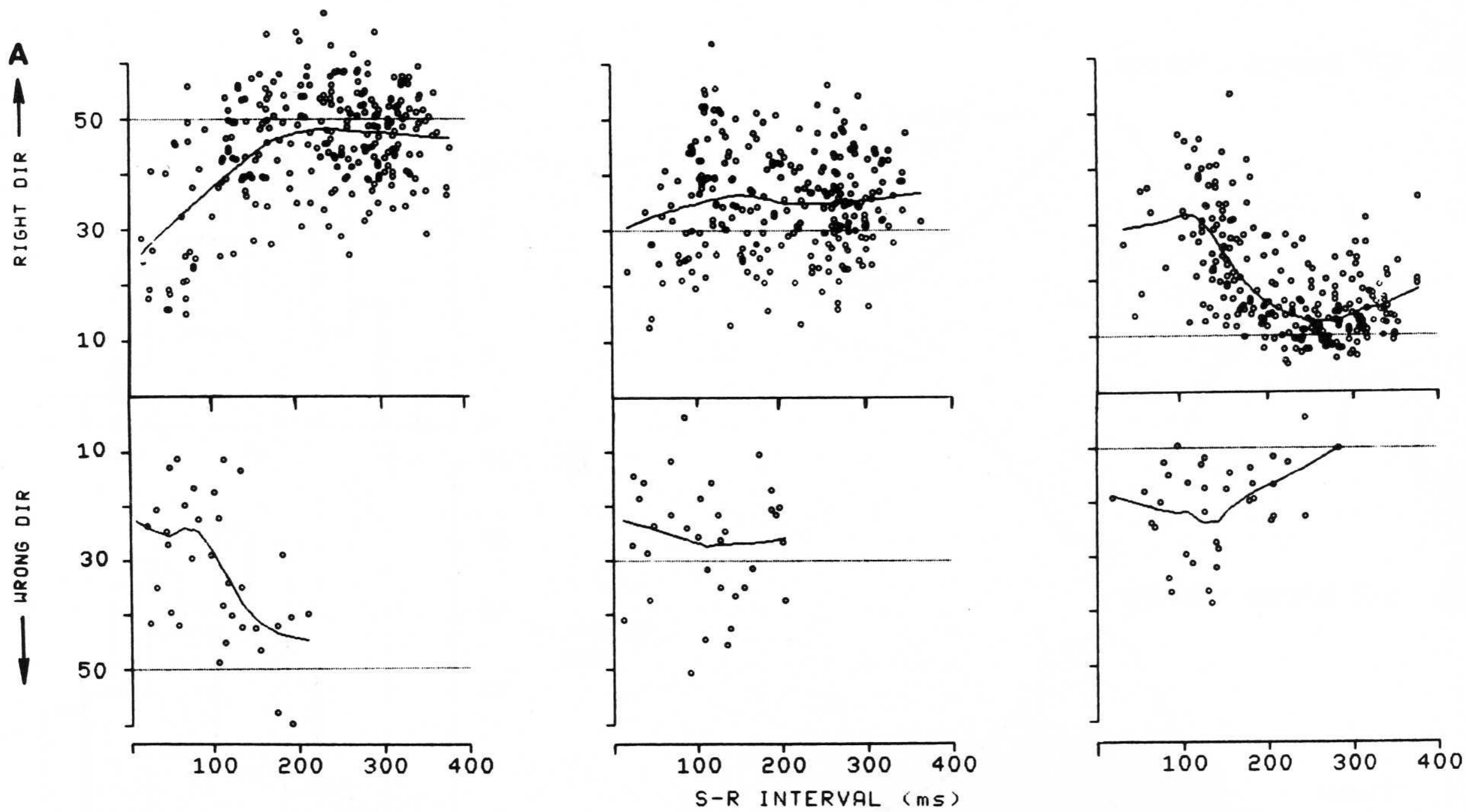

[Favilla et al. 1989]

# Experimental results of Henig et al

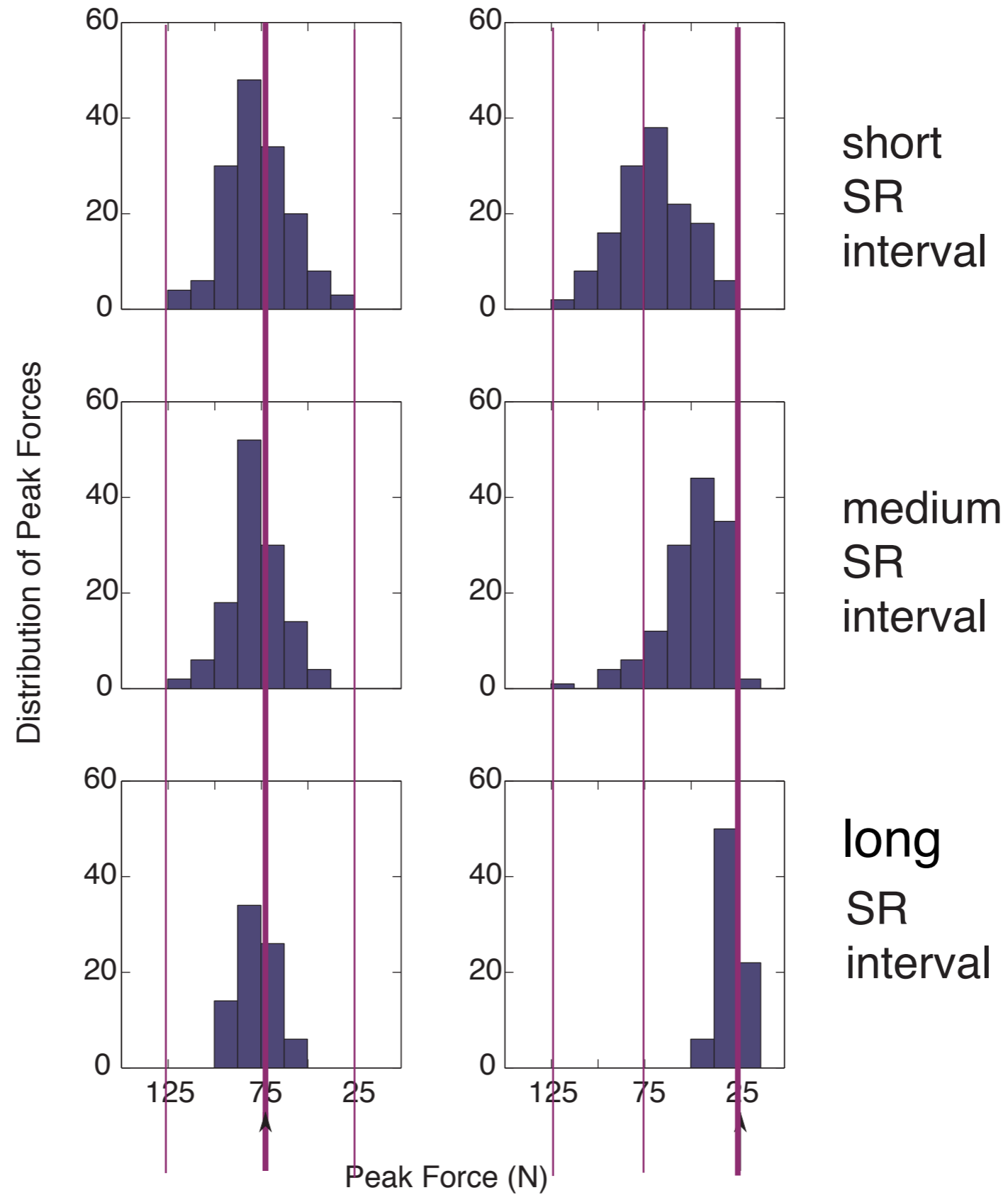

### theoretical account for Henig et al.

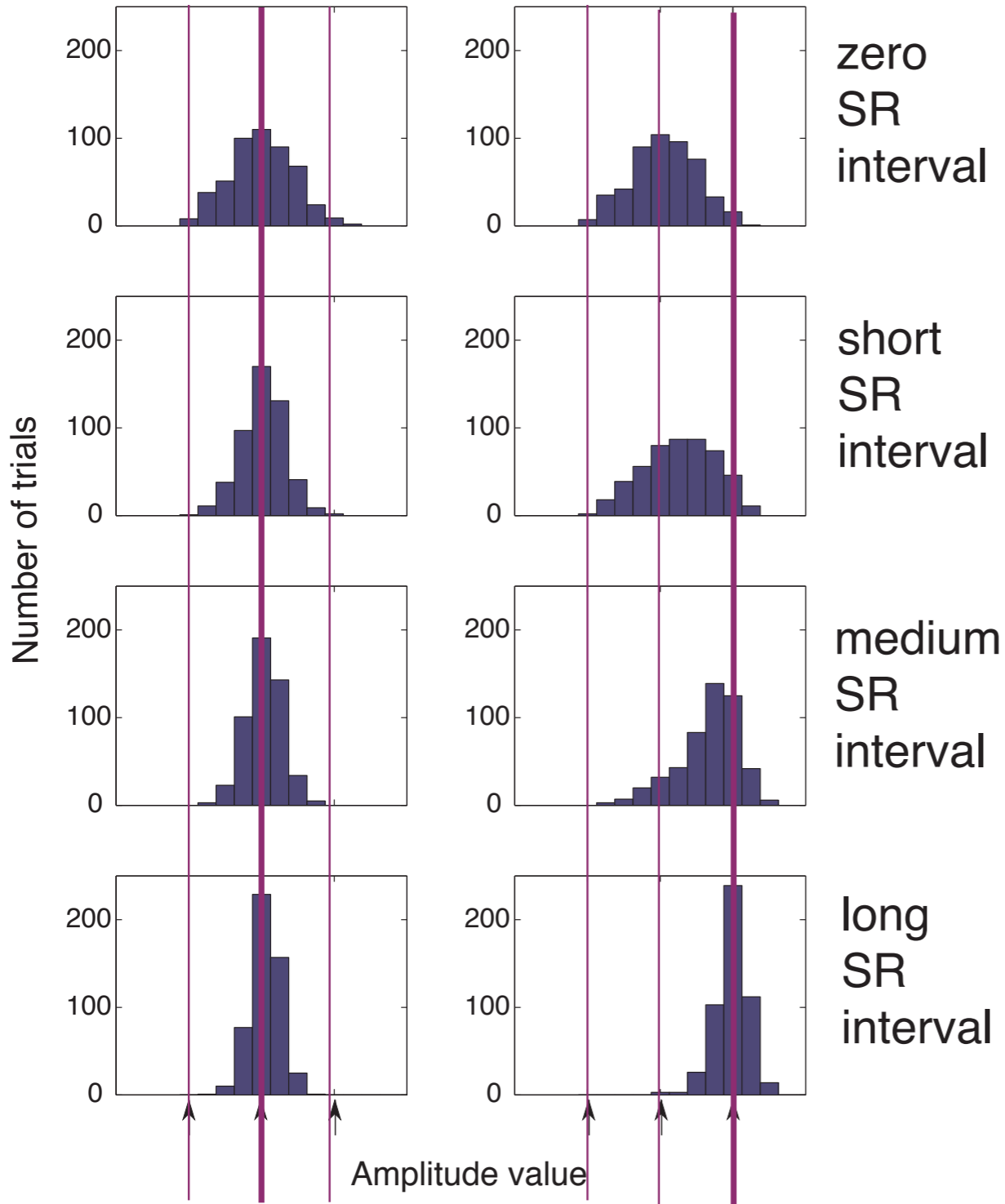

### Experimental results of Henig et al

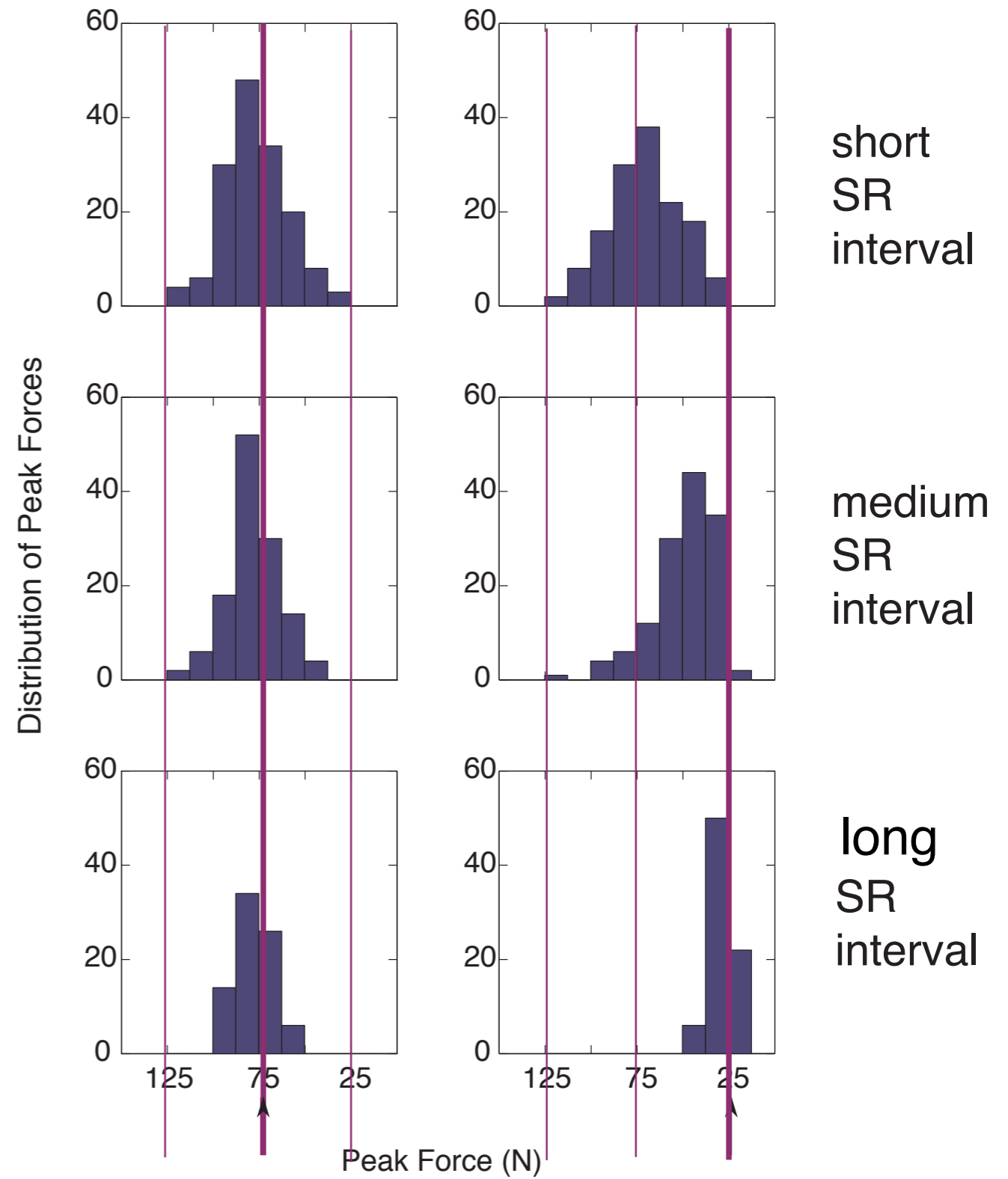

■ infer width of  
preshape peaks  
in field

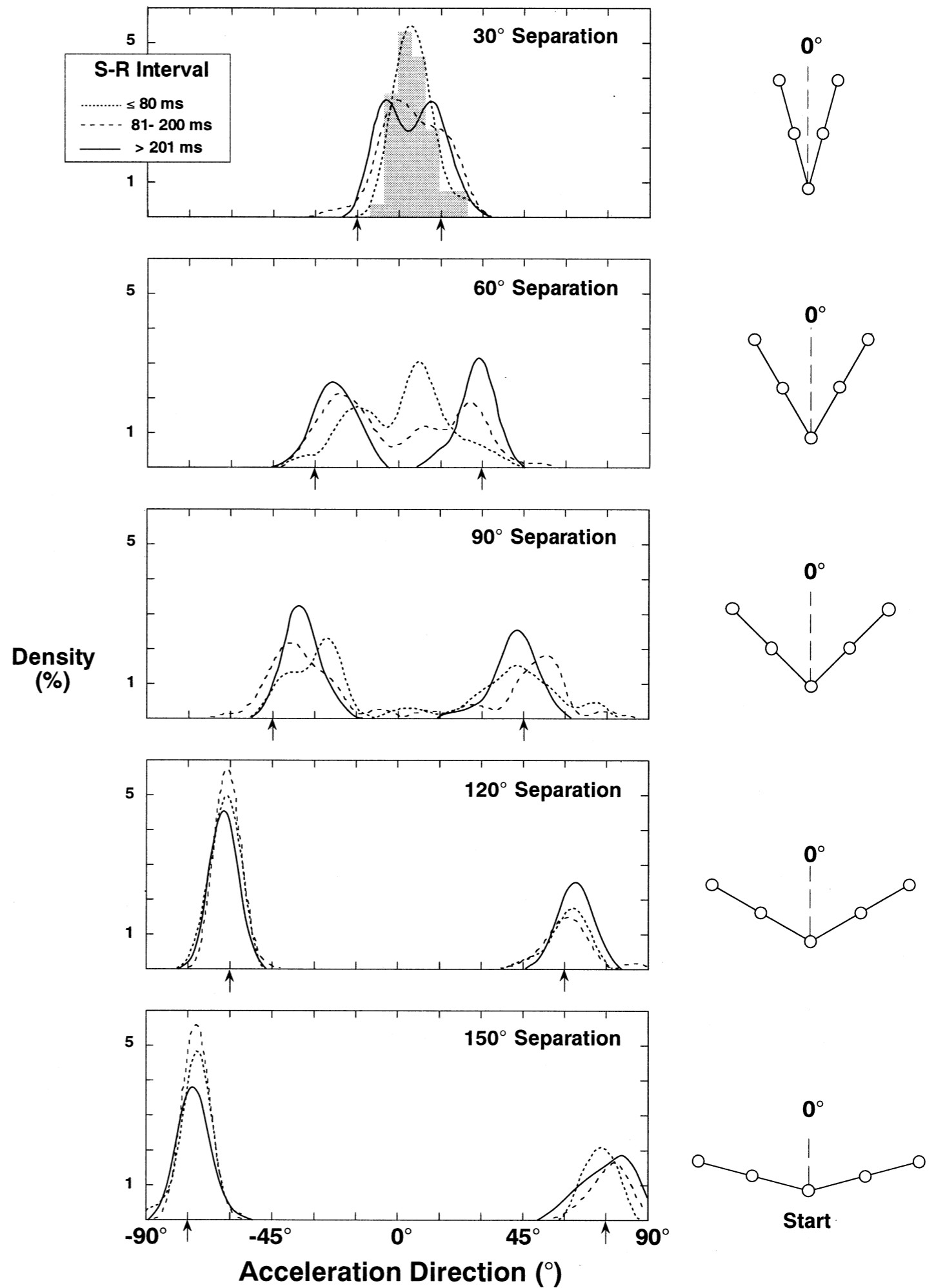

[Ghez et al 1997]

probability in timed movement initiation

rare frequent

rare frequent

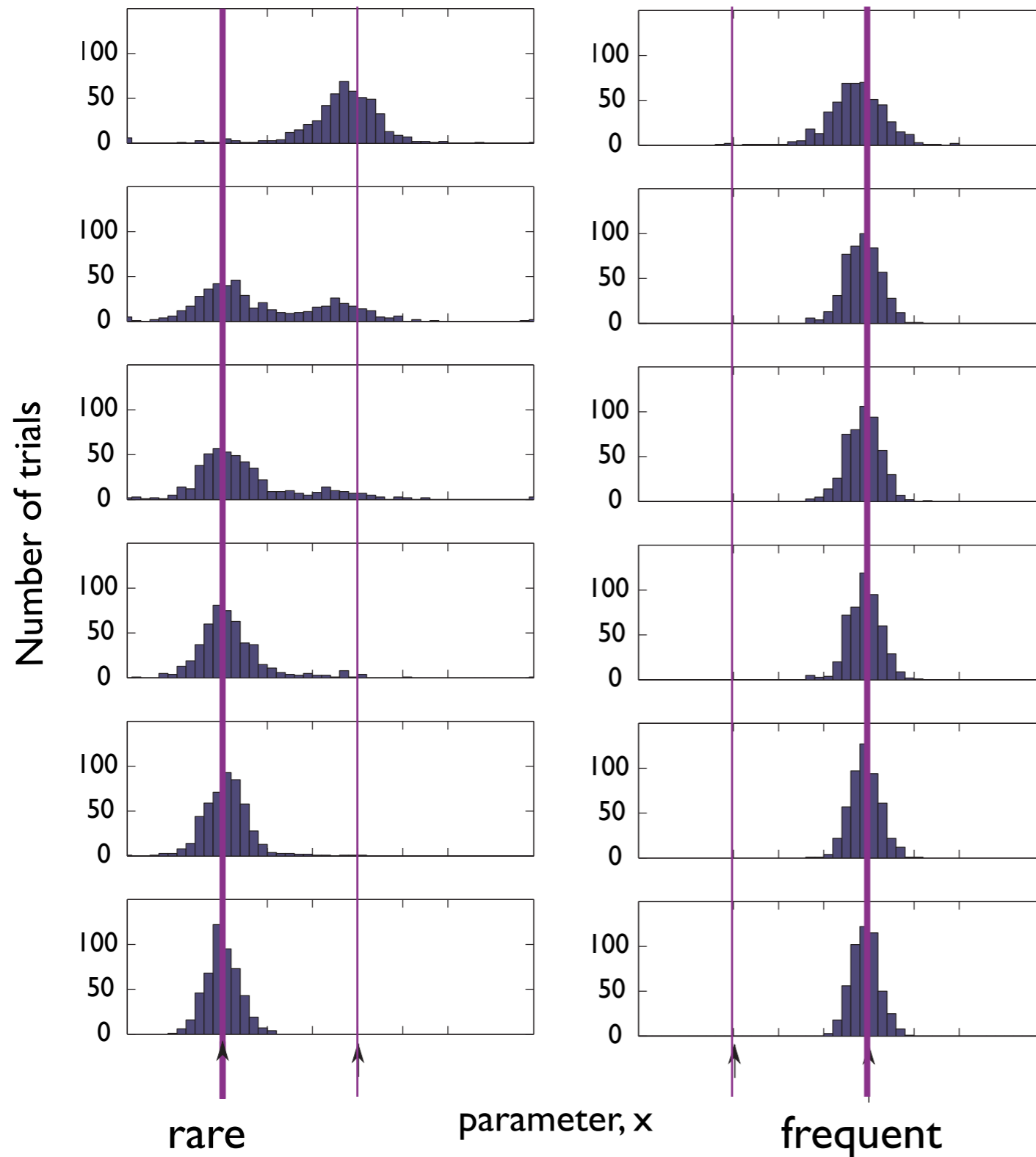

short SR interval:  
observe preshape

long SR interval:  
observe stimulus-defined  
movement plan

# Conclusion

- DFT concept of selection decisions supported by ample behavioral signatures
- multiple contributions to specification
  - task set/preshape
  - imperative signal /go signal
- metrics of task layout matters
- time course of decision making can be understood ...